

Biarritz



Ardoise

Cendre

Cognac

Écru

Mélange

*40x80 . 16" x 32" . 40x40 . 16" x 16"
20x40 . 8" x 16" . 20x20 . 8" x 8" . 10x10 . 4" x 4"*

*60x60 19mm . 24" x 24"
rettificato*



Biarritz

Sulle coste sabbiose di Biarritz un tempo salutate dal passaggio delle balene atlantiche, sorgono monumenti e scorci di grande eleganza. Il fascino delle onde marine che ne accarezzano le spiagge, l'hanno trasformata nella California dell'Europa, luogo prediletto per il surf e la vita di mare. Con il suo stile ricercato sempre attento alle mode e alle tendenze, Biarritz, fulcro di una mondanità e un jet set per nulla scontati, ispira una collezione di pavimenti e rivestimenti pensata per vestire d'eleganza la dolce vita contemporanea. Delicate texture che mescolano geometrie a elementi floreali perfettamente abbinabili fra loro, accompagnano le superfici di questa collezione, per riportare negli spazi tutta la bellezza della pietra. L'ampia gamma di formati modulari e la ricchezza dei colori consentono soluzioni decorative di grande impatto visivo, rendendo Biarritz la soluzione perfetta per personalizzare con pavimenti e rivestimenti, ambienti interni e spazi esterni.

On the sandy coasts around Biarritz, sometimes visited by passing Atlantic whales, there are monuments and views of great elegance. The appeal of the ocean waves pounding onto the beaches has transformed it into Europe's California, and a favourite resort for surfing and seaside living. With its classy style and a constant eye kept on fashions and the latest trends, Biarritz, pinnacle of sophistication and home to a jet set to be reckoned with, inspires a collection of floors and walls devised to clothe this contemporary, laid-back lifestyle with elegance. Delicate textures mixing geometrical designs with floral elements that match each other to perfection are to be found on the surfaces in this collection, to bring back all the beauty of stone to the surroundings. The wide range of modular sizes and the richness of the colours enable decorative solutions of great visual impact to be achieved, making Biarritz the ideal solution to customize the floors and walls of indoor and outdoor areas.

Les côtes sableuses de Biarritz, autrefois saluées par le passage des baleines de l'Atlantique, offrent aux regards des monuments et des vues d'une grande élégance. Le charme des vagues caressant ses plages en ont fait la Californie de l'Europe, un lieu de prédilection des surfeurs et des amateurs de mer. Avec son style recherché, attentif aux modes et aux tendances, Biarritz, cœur d'une mondanité et d'une jet-set souvent imprévisibles, a été source d'inspiration pour une collection de revêtements sol et mur, conçue pour donner de l'élégance à la « dolce vita » contemporaine. De délicates textures, qui mêlent géométries et éléments floraux faciles à coordonner, accompagnent les surfaces de cette collection, pour apporter dans les espaces toute la beauté de la pierre. La vaste gamme de formats modulaires et la richesse des coloris permettent des solutions décoratives au grand impact visuel, et font de Biarritz la solution idéale pour personnaliser les espaces intérieurs et extérieurs grâce aux revêtements de sol et de mur.

An der sandigen Küste von Biarritz, die einst von den Walfischen des Atlantischen Ozeans heimgesucht wurden, befinden sich höchst elegante Monumente und Ausblicke. Die charmanten Wellen, die die Strände streicheln, haben den Ort zum europäischen Kalifornien gemacht, einen für den Surfsport und das Strandleben bevorzugten Ort. Dank seines anspruchsvollen Stils, der stets auf Moden und Trends achtet, hat Biarritz als mondäner Mittelpunkt eines ganz und gar nicht abgedroschenen Jet Set eine Boden- und Wandverkleidungskollektion für eine elegante Ausstattung der kontemporären ‚Dolce Vita‘ inspiriert. Zarte Texturen, die Geometrien mit perfekt untereinander kombinationsfähigen Blumenelementen mischen, begleiten die Oberflächen dieser Kollektion, um die volle Schönheit von Stein wieder in die Räume zu schaffen. Das umfangreiche Sortiment modularer Formate und die satten Farben ermöglichen höchst eindrucksvolle Dekorationen und machen aus Biarritz die perfekte Lösung für die Personalisierung von Böden und Wänden, Innen- und Außenbereichen.

На песчаных берегах Биаррица, которые в свое время приветствовали проплывавшие мимо киты, высятся памятники и открываются элегантные виды. Очарование морских волн, ласкающих пляжи, превратило его в европейскую Калифорнию - наилучшее место для серфинга и жизни на море. Благодаря своему изысканному стилю, который всегда внимателен к моде и к ее тенденциям, Биарриц, настоящий центр светской жизни и место притяжения элиты общества, вдохновляет собой коллекцию напольной и облицовочной плитки, задуманной для элегантного оформления современной сладкой жизни. Нежная текстура, смешивающая отлично сочетающиеся друг с другом геометрию и цветочные элементы, украшает поверхности этой коллекции, воспроизводя в пространствах всю красоту камня. Большая гамма модульных форматов и изысканность цветов позволяют получать декоративные решения с сильным зрительным эффектом, превращая Biarritz в идеальное решение для индивидуального оформления интерьеров и наружных пространств при помощи полов и облицовки стен.

Écru

- Rivestimento: Écru 40x40, 20x40, 20x20
Waikiki Écru 40x40, 20x20
Pavimento: Écru 40x80, 40x40
- ✓ Waikiki Écru 40x40 **RII** 



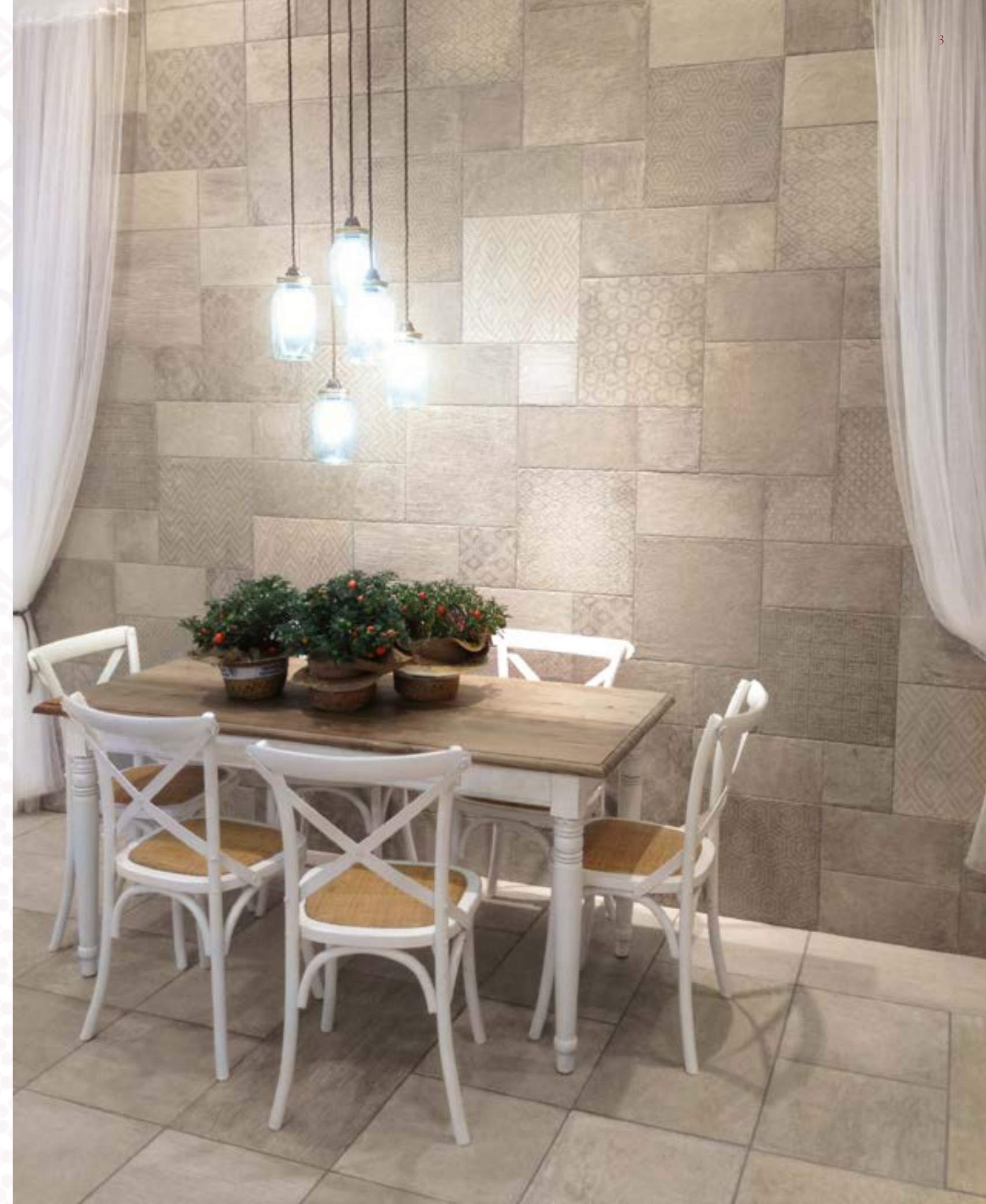





- < Rivestimento: Écru 10x10
- Decoro Paradise Écru s/6 10x10, 20x20
- Pezzi speciali Écru
- Pavimento: Decoro Paradise Écru s/6 20x20
- ✓ Écru 20x20





Écru

< Waikiki Écru 20x20
Muretto: London serie Underground

- > Écru 20x20
- Écru 20x20 **R11** 







Écru

< Écru 40x80, 40x40, 20x40
(modulare 26 pag. 52)

✓ Écru 20x20
Decoro Aloha Écru s/6 20x20





Cognac

- < Cognac 40x40, 20x40, 20x20 (modulare 19 pag. 52)
- Battiscopa Cognac 8x40
- Cognac 40x40
- Mosaico Waikiki Écru >





Cognac

- < Cognac 40x40
- ✓ Waikiki Cognac 20x20







✓ Cognac 40x40, 20x40, 20x20
Waikiki Cognac 40x40, 20x20





Cognac

- Cognac 20x20 R11 
- Elemento ad "L" Cognac R11 
- Waikiki Cognac 20x20 R11 
- Waikiki Cognac 20x20 R11 





Cendre

< Cendre 40x80, 40x40, 20x40 RII 
(modulare 25 pag. 52)

> Cendre 20x20 RII 







Cendre

- < Cendre 10x10
- Waikiki Cendre 10x10, 20x20
- Pezzi speciali Cendre

^ > Waikiki Cendre 20x20



Cendre

- ✓ Rivestimento: Cendre 20x20
- Decoro Paradise Cendre A-B-C-D-E-F s/1 20x20
- Sigaro Biarritz Ardoise 2,5x20
- Pavimento: Ardoise 20x20



- ✓ Insetto Paradise Cendre C s/I 20x20
- ✓ Insetto Paradise Cendre s/6 20x20



- ✓ Rivestimento: Cendre 20x20
Decoro Paradise Cendre
A-B-C-D-E-F s/I 20x20
- ✓ Pavimento: Cendre 40x40, 20x40, 20x20
(modulare 10)





Cendre

- < Cendre 40x80
- ✓ Rivestimento: Cendre 20x20, 10x10
- Decoro Aloha Cendre s/6 10x10, 20x20
(modulare Aloha Cendre pag. 45)
- Pavimento: Cendre 40x40





- ✓ Ardoise 40x40
Waikiki Ardoise 40x40, 10x10
Gradone square Ardoise



Ardoise

- < Ardoise 20x40 RII 
- Mosaico spacco Ardoise 30x40 RII 
- > Ardoise 20x20 RII 





Ardoise

- < Ardoise 20x20, 10x10
(modulare Waikiki pag. 45)
- ✓ Ardoise 20x20 **R11**





Ardoise

- ◀ Waikiki Ardoise 20x20
- ✓ Ardoise 40x40, 20x40, 20x20
(modulare 17, pag. 52)
- ◀ Waikiki Ardoise 40x40, 10x10
Gradone square Ardoise







Mélange

< 7 Mélange 40x40, 20x40, 20x20 **RII** 
(modulare 10, pag. 52)

> Mélange 20x20 **RII** 







Mélange

- < Mélange 40x40, 20x40, 20x20
(modulare IO, pag. 52)
- > Mélange 20x20, 10x10
Decoro Aloha Mélange s/6 20x20, 10x10
(modulare Aloha mélange, pag. 45)





Mélange

< Mélange 40x80

> Rivestimento: Mélange 20x20
Waikiki Cendre 10x10
Muretto: London serie Underground
Pavimento: Melange 40x40







Biarritz

colori

Colours
Couleurs
Lieferbar
ЦВЕТА

caratteristiche tecniche

technical features
caractéristiques techniques
technische eigenschaften
ТЪХНИЧЪСКИЪ ХКРККЪРИСТИКИ



Biarritz



Écru

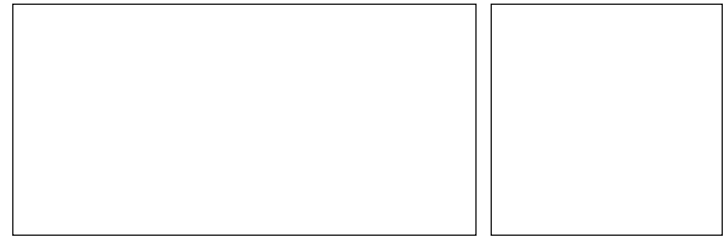

40x80 . 16"x32"
40x80 . 16"x32"



40x40 . 16"x16"
40x40 . 16"x16"



20x40 . 8"x16"
20x40 . 8"x16"



20x20 . 8"x8"
20x20 . 8"x8"



10x10 . 4"x4"

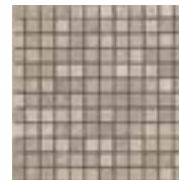

Mosaico Mix Beige
(Écru, Cognac)
30x30 - 12"x12"
(2,2x2,2 - 7/8x7/8)

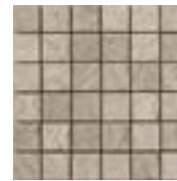

Mosaico Mix Beige
(Écru, Cognac)
30x30 - 12"x12"
(5x5 - 2"x2")



Mosaico Spacco **R11**
30x40 - 12"x16"
(7,5x7,5 - 3"x3")



waikiki Écru

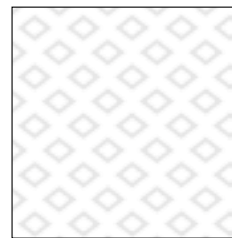

Waikiki mix 40x40 . 16"x16"
Waikiki mix 40x40 . 16"x16"

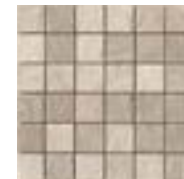

Mosaico Waikiki Écru
30x30 - 12"x12"
(5x5 - 2"x2")



Waikiki mix 20x20 . 8"x8"
Waikiki mix 20x20 . 8"x8"



Waikiki mix 10x10 . 4"x4"

Il decoro waikiki è composto da 14 soggetti nel formato 40x40 e 26 soggetti nei formati 20x20 e 10x10, miscelati casualmente nelle scatole.

Waikiki decor is made of 14 different subjects in size 40x40 and 26 in size 20x20 and 10x10, all of them randomly mixed in the box.

Le décor Waikiki est composé par 14 sujets différents dans le format 40x40 et 26 dans les formats 20x20 et 10x10: ces sujets sont mélangés dans les boîtes en toute casualité.

Das Dekor Waikiki besteht aus 14 verschiedenen Muster in dem Format 40x40 und aus 26 Muster in den Formaten 10x10 und 20x20. Die Dekore werden nur kartonsweise verkauft und sind zufällig gemischt.

Декор waikiki состоит из 14 видов рисунка в формате 40x40 и 26 видов рисунка в форматах 20x20 и 10x10 аккуратно перемешанных внутри коробок.

40x80-16"x32". 40x40-16"x16". 20x40-8"x16". 20x20-8"x8". 10x10-4"x4"

Cognac

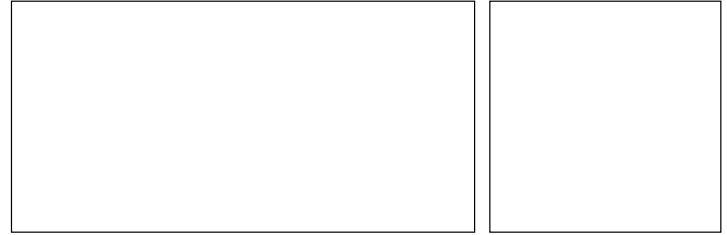

40x80 . 16"x32"
40x80 . 16"x32" **R11**

40x40 . 16"x16"
40x40 . 16"x16" **R11**



20x40 . 8"x16"
20x40 . 8"x16" **R11**

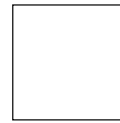

20x20 . 8"x8"
20x20 . 8"x8" **R11**



10x10 . 4"x4"

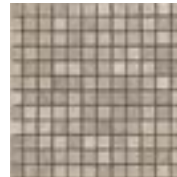

Mosaico Mix Beige
(Écru, Cognac)
30x30 - 12"x12"
(2,2x2,2 - "7/8x7/8")

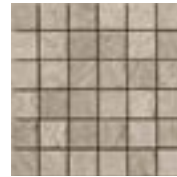

Mosaico Mix Beige
(Écru, Cognac)
30x30 - 12"x12"
(5x5 - 2"x2")



Mosaico Spacco **R11**
30x40 - 12"x16"
(7,5x7,5 - 3"x3")



waikiki Cognac

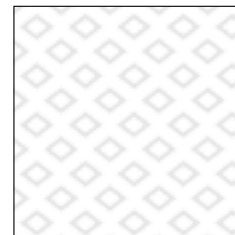

Waikiki mix 40x40 . 16"x16"
Waikiki mix 40x40 . 16"x16" **R11**



Waikiki mix 10x10 . 4"x4"

Waikiki mix 20x20 . 8"x8"
Waikiki mix 20x20 . 8"x8" **R11**

Il decoro waikiki è composto da 14 soggetti nel formato 40x40 e 26 soggetti nei formati 20x20 e 10x10, miscelati casualmente nelle scatole.

Waikiki decor is made of 14 different subjects in size 40x40 and 26 in size 20x20 and 10x10, all of them randomly mixed in the box.

Le décor Waikiki est composé par 14 sujets différents dans le format 40x40 et 26 dans les formats 20x20 et 10x10; ces sujets sont mélangés dans les boîtes en toute casualité.

Das Dekor Waikiki besteht aus 14 verschiedenen Muster in dem Format 40x40 und aus 26 Muster in den Formaten 10x10 und 20x20. Die Dekoren werden nur kartonsweise verkauft und sind zufällig gemischt.

Декор waikiki состоит из 14 видов рисунка в формате 40x40 и 26 видов рисунка в форматах 20x20 и 10x10 аккуратно перемешанных внутри коробок.



Cendre

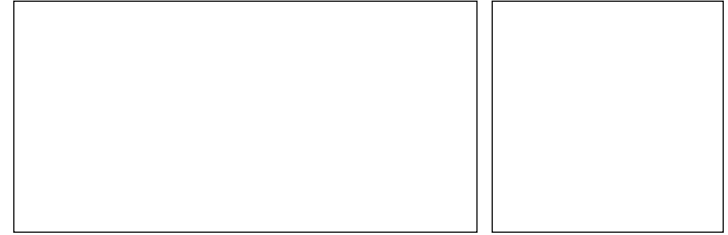

40x80 . 16"x32"
40x80 . 16"x32" **R11**

40x40 . 16"x16"
40x40 . 16"x16" **R11**



20x40 . 8"x16"
20x40 . 8"x16" **R11**



20x20 . 8"x8"
20x20 . 8"x8" **R11**



10x10 . 4"x4"

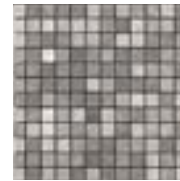

Mosaico Mix Grigio
(Ardoise, Cendre)
30x30 - 12"x12"
(2,2x2,2 - 7/8x7/8)

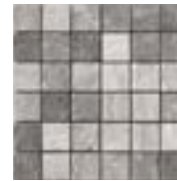

Mosaico Mix Grigio
(Ardoise, Cendre)
30x30 - 12"x12"
(5x5 - 2"x2")



Mosaico Spacco **R11**
30x40 - 12"x16"
(7,5x7,5 - 3"x3")



waikiki Cendre

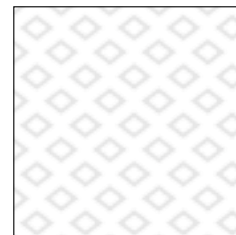

Waikiki mix 40x40 . 16"x16"
Waikiki mix 40x40 . 16"x16" **R11**



Mosaico Waikiki Cendre
30x30 - 12"x12"
(5x5 - 2"x2")



Waikiki mix 10x10 . 4"x4"

Waikiki mix 20x20 . 8"x8"
Waikiki mix 20x20 . 8"x8" **R11**

Il decoro waikiki è composto da 14 soggetti nel formato 40x40 e 26 soggetti nei formati 20x20 e 10x10, miscelati casualmente nelle scatole.

Waikiki decor is made of 14 different subjects in size 40x40 and 26 in size 20x20 and 10x10, all of them randomly mixed in the box.

Le décor Waikiki est composé par 14 sujets différents dans le format 40x40 et 26 dans les formats 20x20 et 10x10: ces sujets sont mélangés dans les boîtes en toute casualité.

Das Dekor Waikiki besteht aus 14 verschiedenen Muster in dem Format 40x40 und aus 26 Muster in den Formaten 10x10 und 20x20. Die Dekore werden nur kartonsweise verkauft und sind zufällig gemischt.

Декор waikiki состоит из 14 видов рисунка в формате 40x40 и 26 видов рисунка в форматах 20x20 и 10x10 аккуратно перемешанных внутри коробок.

40x80-16"x32". 40x40-16"x16". 20x40-8"x16". 20x20-8"x8". 10x10-4"x4"

Ardoise

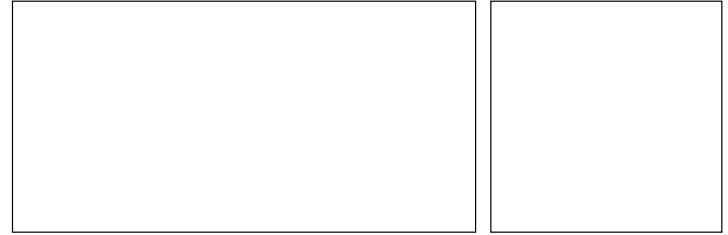

40x80 . 16"x32"
40x80 . 16"x32" **R11**

40x40 . 16"x16"
40x40 . 16"x16" **R11**



20x40 . 8"x16"
20x40 . 8"x16" **R11**



20x20 . 8"x8"
20x20 . 8"x8" **R11**



10x10 . 4"x4"

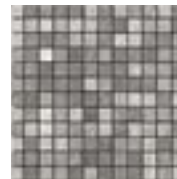

Mosaico Mix Grigio
(Ardoise, Cendre)
30x30 - 12"x12"
(2,2x2,2 - "7/8x7/8")

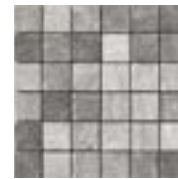

Mosaico Mix Grigio
(Ardoise, Cendre)
30x30 - 12"x12"
(5x5 - 2"x2")



Mosaico Spacco **R11**
30x40 - 12"x16"
(7,5x7,5 - 3"x3")

waikiki Ardoise

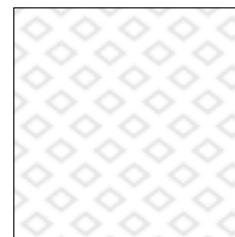

Waikiki mix 40x40 . 16"x16"
Waikiki mix 40x40 . 16"x16" **R11**



Waikiki mix 20x20 . 8"x8"
Waikiki mix 20x20 . 8"x8" **R11**



Waikiki mix 10x10 . 4"x4"

Il decoro waikiki è composto da 14 soggetti nel formato 40x40 e 26 soggetti nei formati 20x20 e 10x10, miscelati casualmente nelle scatole.

Waikiki decor is made of 14 different subjects in size 40x40 and 26 in size 20x20 and 10x10, all of them randomly mixed in the box.

Le décor Waikiki est composé par 14 sujets différents dans le format 40x40 et 26 dans les formats 20x20 et 10x10: ces sujets sont mélangés dans les boîtes en toute casualité.

Das Dekor Waikiki besteht aus 14 verschiedenen Muster in dem Format 40x40 und aus 26 Muster in den Formaten 10x10 und 20x20. Die Dekore werden nur kartonsweise verkauft und sind zufällig gemischt.

Декор waikiki состоит из 14 видов рисунка в формате 40x40 и 26 видов рисунка в форматах 20x20 и 10x10 аккуратно перемешанных внутри коробок.

Biarritz



Mélange

composto da:
Cendre, Ecrú

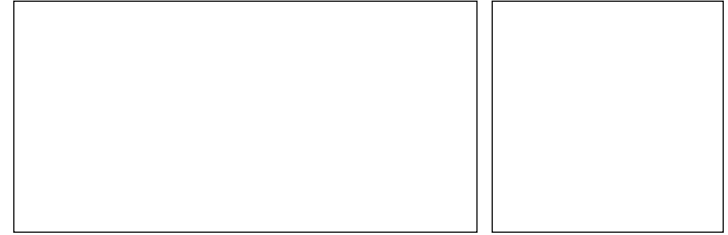

40x80 . 16"x32"
40x80 . 16"x32" **R11**

40x40 . 16"x16"
40x40 . 16"x16" **R11**



20x40 . 8"x16"
20x40 . 8"x16" **R11**



20x20 . 8"x8"
20x20 . 8"x8" **R11**



10x10 . 4"x4"

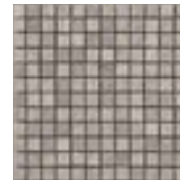

Mosaico Mélange
30x30 - 12"x12"
(2,2x2,2 - "7/8x"7/8)

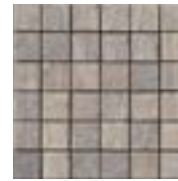

Mosaico Mélange
30x30 - 12"x12"
(5x5 - 2"x2")



Mosaico Spacco **R11**
30x40 - 12"x16"
(7,5x7,5 - 3"x3")

Imballaggi

Packing - Emballage - Verpackung . Упаковка

	BOX			PALLET	
	PC	SQM	KGS	BOXES	SQM
40x80 . 16"x32"	3	0,96	24,00	28	26,88
40x40 . 16"x16"	7	1,12	28,00	48	53,76
40x40 . 16"x16"	6	0,96	22,70	52	46,08
20x40 . 8"x16"	11	0,88	20,60	54	47,52
20x20 . 8"x8"	22	0,88	20,60	54	47,52
10x10 . 4"x4"	60	0,60	15,00	72	43,20

40x80-16"x32" . 40x40-16"x16" . 20x40-8"x16" . 20x20-8"x8" . 10x10-4"x4"

Pezzi Speciali . Trims . Pièces Spéciales . Formstücke . Специальные изделия .

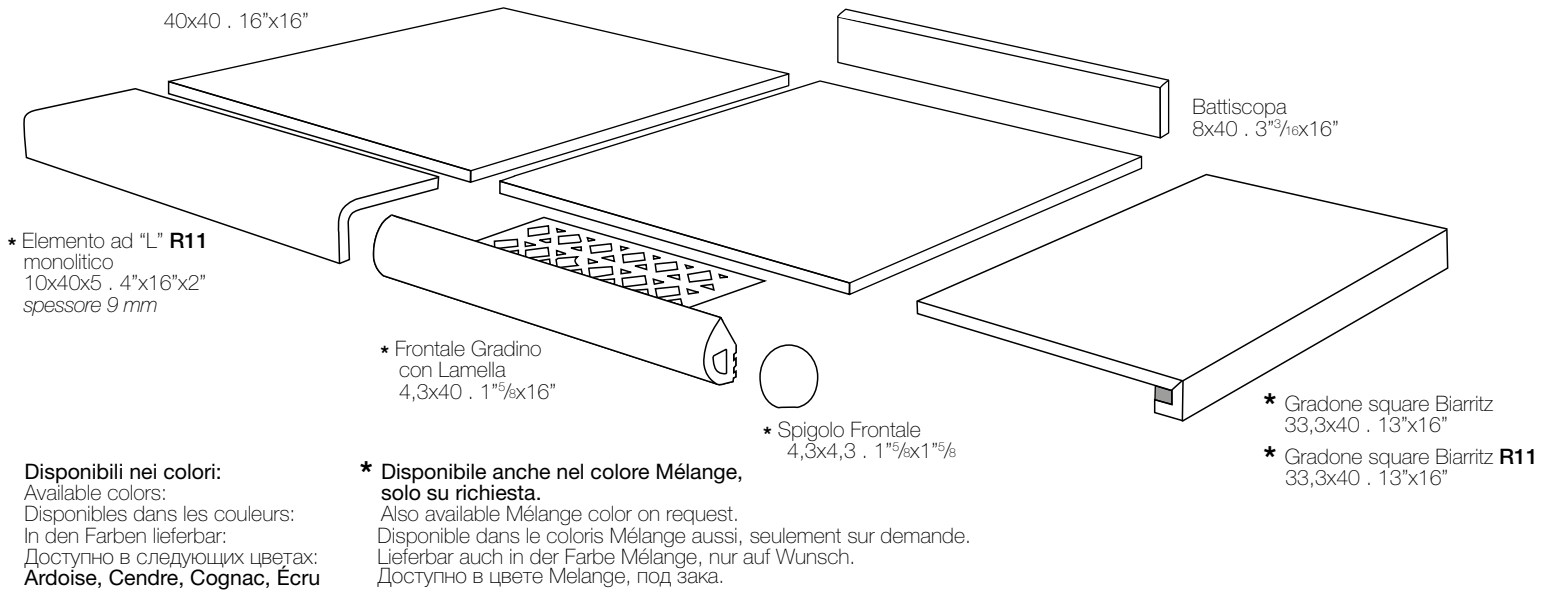

Pezzi Speciali 10x10

Trims . Pièces Spéciales . Formstücke . Специальные изделия .

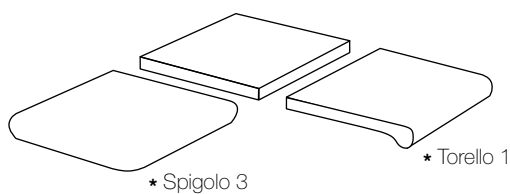

Disponibili nei colori:
Available colors:
Disponibles dans les couleurs:
In den Farben lieferbar:
Доступно в следующих цветах:
Ardoise, Cendre, Cognac, Ecreu

* Disponibile anche nel colore **Mélange**,
solo su richiesta.
Also available **Mélange** color on request.
Disponibile dans le coloris **Mélange** aussi, seulement sur demande.
Lieferbar auch in der Farbe **Mélange**, nur auf Wunsch.
Доступно в цвете **Mélange**, под заказ.



Decori . Decors. Décors. Dekore. Декоры

paradise

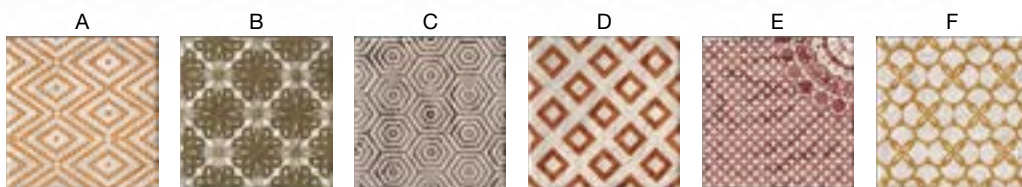

Inserto Paradise Écru A/B/C/D/E/F s/1
20x20 . 8"x8"

Inserto Paradise Écru s/6
20x20 . 8"x8"



Inserto Paradise Écru s/6
10x10 . 4"x4"

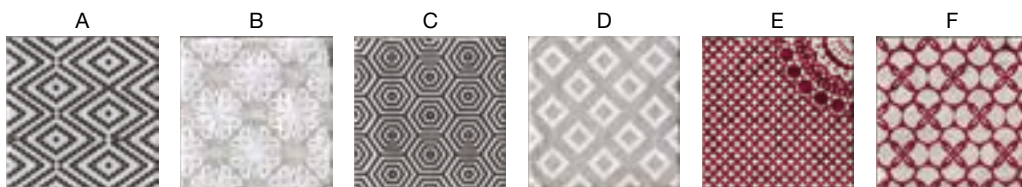

Inserto Paradise Cendre A/B/C/D/E/F s/1
20x20 . 8"x8"

Inserto Paradise Cendre s/6
20x20 . 8"x8"



Inserto Paradise Cendre s/6
10x10 . 4"x4"

Aloha



Inserto Aloha Écru s/6
20x20 . 8"x8"



Inserto Aloha Écru s/6
10x10 . 4"x4"



Inserto Aloha Cendre s/6
20x20 . 8"x8"

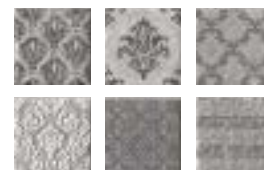

Inserto Aloha Cendre s/6
10x10 . 4"x4"

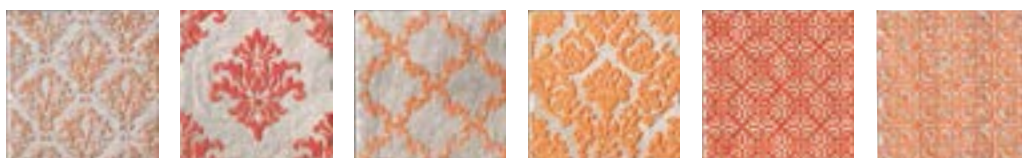

Inserto Aloha Mélange s/6
20x20 . 8"x8"



Inserto Aloha Mélange s/6
10x10 . 4"x4"

Biarritz



Sigaro Biarritz
Ardoise
2,5x20 . "15/16x8"

Sigaro Biarritz
Cognac
2,5x20 . "15/16x8"

Schemi di posa

Laying sketch . Schémas de pose . Modulverlegungsbeispiele . Схемы Укладки



*** MODULARE ALOHA ÉCRU (1 Mq. Nominale)**

Écru 10x10 = 26 pzz
 Écru 20x20 = 11 pzz
 Inserto Aloha Écru s/6 20x20 = 6 pzz
 Inserto Aloha Écru s/6 10x10 = 6 pzz

*** MODULARE ALOHA CENDRE (1 Mq. Nominale)**

Cend्रे 10x10 = 26 pzz
 Cend्रे 20x20 = 11 pzz
 Inserto Aloha Cend्रे s/6 20x20 = 6 pzz
 Inserto Aloha Cend्रे s/6 10x10 = 6 pzz

*** MODULARE ALOHA MÉLANGE (1 Mq. Nominale)**

10x10 = 26 pzz
 20x20 = 11 pzz
 Inserto Aloha Mélange s/6 20x20 = 6 pzz
 Inserto Aloha Mélange s/6 10x10 = 6 pzz

*** Solo per rivestimento**

Fixing for wall only
 Pose que pour le revêtement mural
 Nur fuer die Wandklebung geeignet
 Композиция только для укладки на стену



MODULARE PARADISE ÉCRU (1 Mq. Nominale)

Écru 10x10 = 26 pzz
 Écru 20x20 = 11 pzz
 Inserto Paradise Écru s/6 20x20 = 6 pzz
 Inserto Paradise Écru s/6 10x10 = 6 pzz

MODULARE PARADISE CENDRE (1 Mq. Nominale)

10x10 = 26 pzz
 20x20 = 11 pzz
 Inserto Paradise Cend्रे s/6 20x20 = 6 pzz
 Inserto Paradise Cend्रे s/6 10x10 = 6 pzz



MODULARE WAIKIKI (1 Mq. Nominale)

(nei colori: Ardoise, Cend्रे, Cognac, Écru)
 10x10 = 26 pzz
 20x20 = 11 pzz
 Waikiki 20x20 = 6 pzz
 Waikiki 10x10 = 6 pzz

Biarritz
 Diciannove



19 mm^{-13/16}
 spessore
 thickness
 épaisseur
 stärke
 толщина

19 millimetri
RETTIFICATO
 rectified / rectifié / rektifiziert / ректифицированный

Cendre 19mm

✓ Cendre 19mm 60x60 rett **R11** 





V4



60x60-24"x24"

ardoise R11 60x60. 24"x24" rett

cendre R11 60x60. 24"x24" rett

écreu R11 60x60. 24"x24" rett

Biarritz
Diciannove

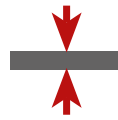

19 mm - ¹³/₁₆
spessore
thickness
épaisseur
stärke
толщина

19 millimetri
RETTIFICATO
rectified / rectifié / rektifiziert / ректифицированный

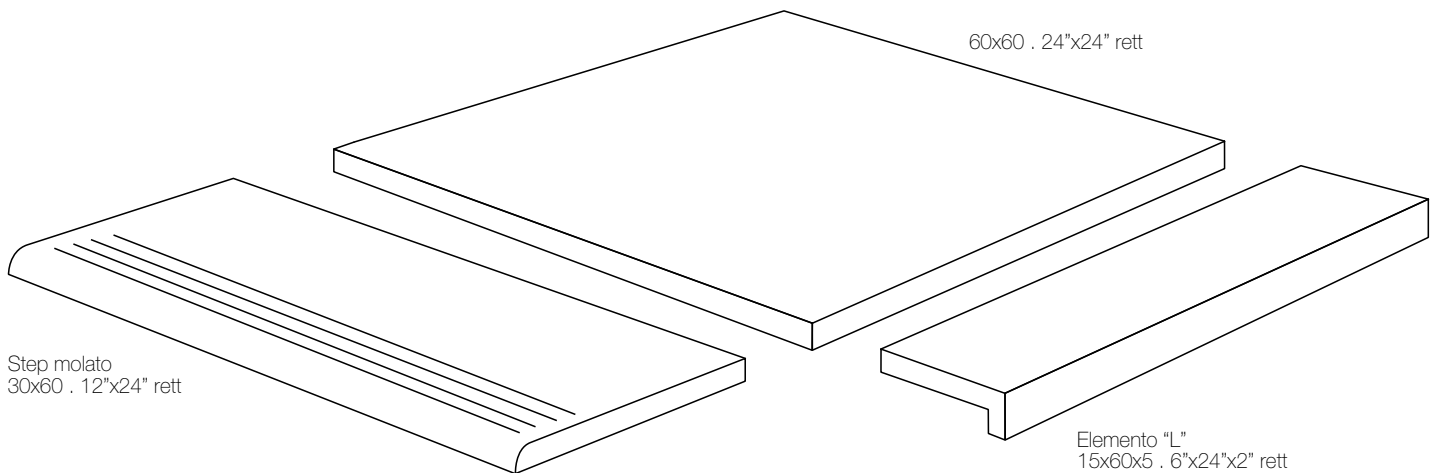

Disponibili nei colori:

Available colors:

Disponibles dans les couleurs:

In den Farben lieferbar:

Поставляется следующих цветов:

Ardoise, Cendre, Écreu

Imballaggi

Packing - Emballage - Verpackung . Упаковка

	BOX			PALLET	
	PC	SQM	KGS	BOXES	SQM
60x60 . 24"x24"	2	0,72	30,80	32	23,04

Biarritz
Diciannove



19 millimetri
RETTIFICATO
rectified / rectifié / rektifiziert / ректифицированный

19 millimetri - superficie antiscivolo R11 - formato 60x60 - disponibile nei colori Ardoise, Écru e Cendre
 19 millimeters - R11 antislip surface - size 60x60 - available in Ardoise, Écru and Cendre
 19 millimètres - surfaces antidérapantes R11 - format 60x60 - disponibles dans Ardoise, Écru et Cendre
 19mm - Rutschfeste Oberflächen R11 - Format 60x60 - In den Farben Ardoise, Écru und Cendre lieferbar
 19миллиметров - антискользкая поверхность R11 - формат 60x60 - Поставляются только в цветах Ardoise, Écru и Cendre

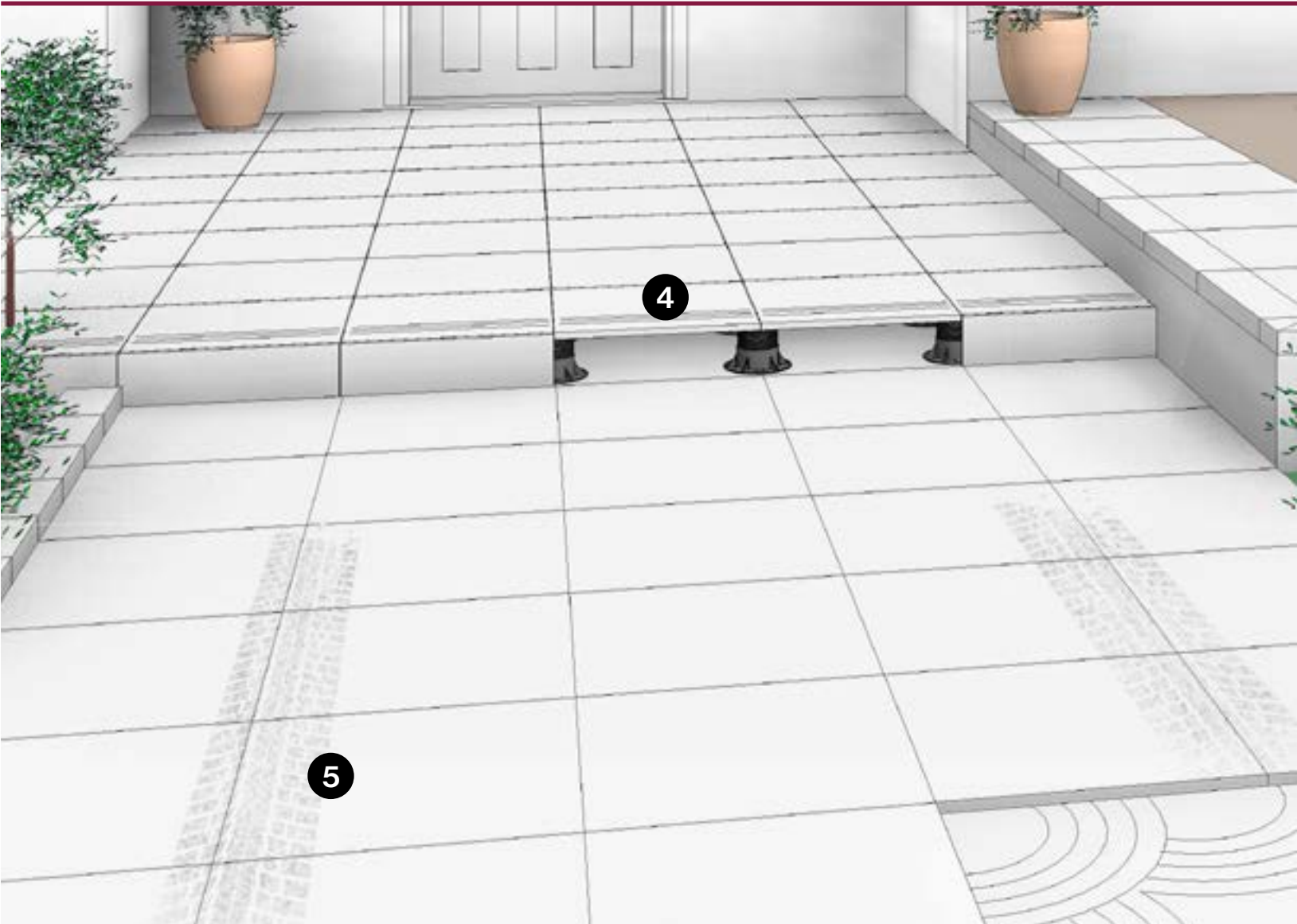



1

POSA A COLLA TRADIZIONALE

Traditional laying with glue
Pose à la colle traditionnelle
Verlegung mit Kleber
Традиционная укладка на клей



2

POSA A SECCO SU GHIAIA E SABBIA

Dry installation onto gravel or sand
Pose à sec sur gravier ou sable
Trockenverlegung in Splitt oder auf Sandbett
Сухая укладка на песок или щебень



3

POSA A SECCO SU ERBA

Dry Installation onto grass
Pose à sec sur gazon
Trockenverlegung auf Rasen
Сухая укладка на траву

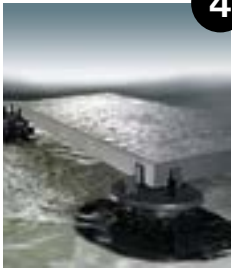

4

POSA SOPRAELEVATA DRENANTE

Installation using a draining raised structure
Pose de drainage élevée
Doppelbodenverlegung auf Stelzlägern mit Drainage
Укладка фальшполов с дренажом

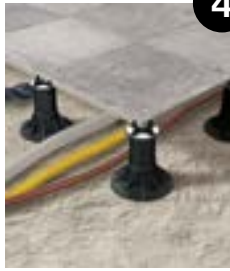

4

POSA SOPRAELEVATA

Installation using a raised structure
Pose de planchers flottants
Doppelbodenverlegung auf regulierbaren Trägern
Укладка фальшполов



5

POSA SU MASSETTO CARRABILE

Laying with glue for carriageable path
Pose sur une allée en béton
Verlegung auf befahrbaren Estrich
Укладка на стяжку для движения транспортных средств

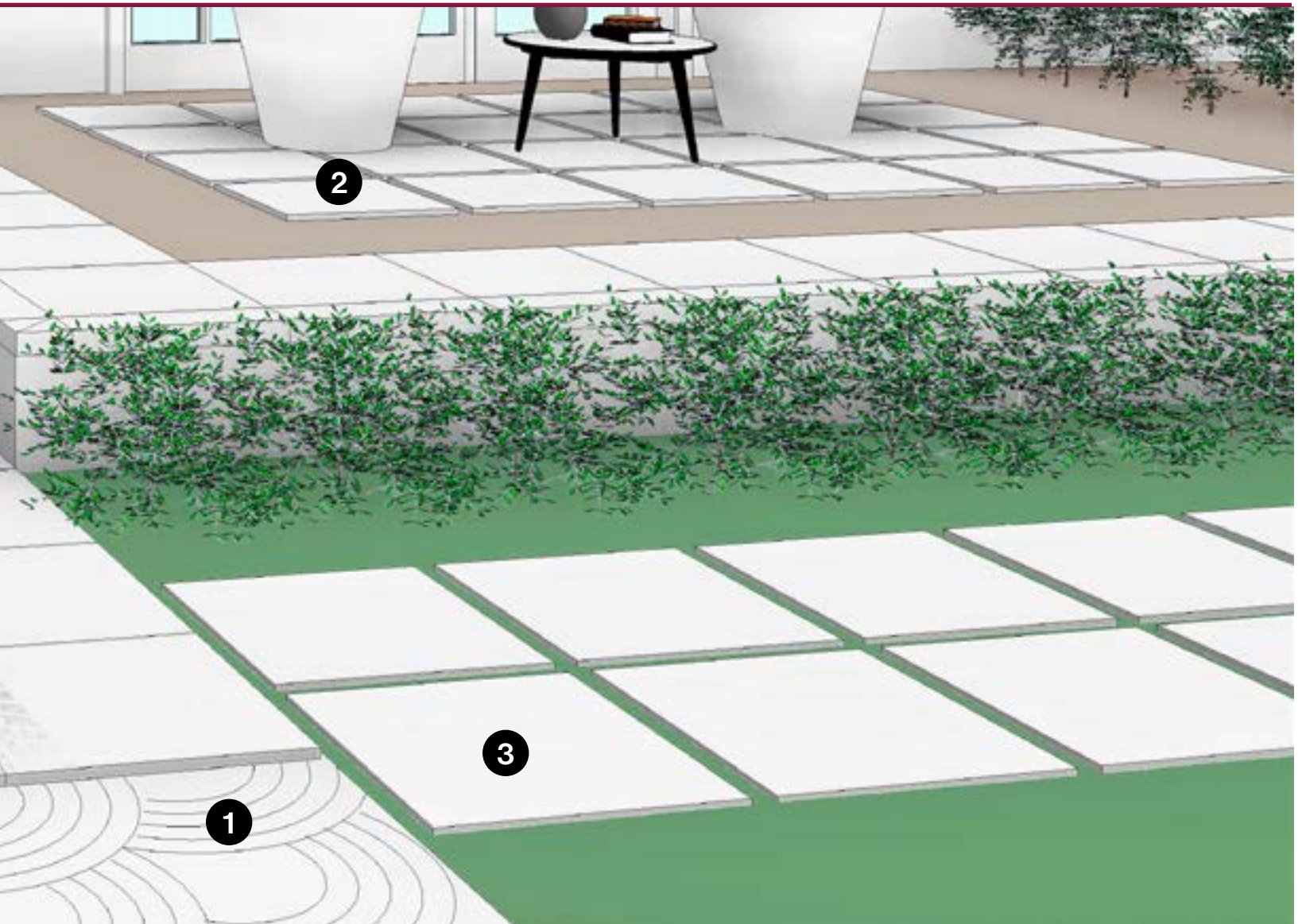

Biarritz
Diciannove



19 mm
spessore
thickness
épaisseur
stärke
толщина

19 millimetri
RETTIFICATO
rectified / rectifié / rektifiziert / ректифицированный

POSA A SECCO SU ERBA

dry Installation onto grass - pose à sec sur gazon - Trockenverlegung auf Rasen - сухая укладка на траву



^ Ecrù

POSA SOPRAELEVATA

Installation using a raised structure - pose de planchers flottants - Doppelbodenverlegung auf regulierbaren Trägern - укладка фальшполов



∨ Ardoise

19MILLIMETRI PER OGNI ESIGENZA

19 millimeters for every need
19 mm pour chaque besoin
19 mm fuer viele Anwendung
19 миллиметров для любых требований

19MILLIMETRI PER OGNI STILE

19 millimeters for every style
19 mm pour chaque style
19 mm fuer jeden Geschmack
19 миллиметров для любого стиля

19MILLIMETRI O U T D O O R

19 millimeters outdoor
19 mm extérieur
19 mm fuer Aussenbereich
19 миллиметров для открытых пространств



^ Ecrù
Ecrù Elemento ad "L"



∨ Cendre

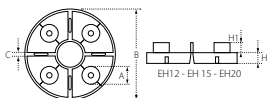

SUPPORTO FISSO
FIXED SUPPORT
SUPPORT FIXE
FESTE TRAGSTRUKTUR
ФИКСИРОВАННАЯ ОПОРА



SUPPORTO REGOLABILE
ADJUSTABLE SUPPORT
SUPPORT RÉGABLE
VERSTELLBARE TRAGSTRUKTUR
РЕГУЛИРУЕМАЯ ОПОРА

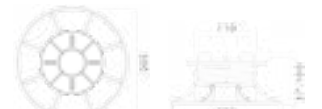

SUPPORTO AUTOLIVELLANTE
SELF-LEVELLING SUPPORT
SUPPORT AUTONIVELANT
SELBTNIVELLERENDE TRAGSTRUKTUR
САМОВЫРАВНИВАЮЩАЯСЯ ОПОРА

Schemi di posa

Laying sketch . Schémas de pose . Modulverlegungsbeispiele . Схемы Укладки

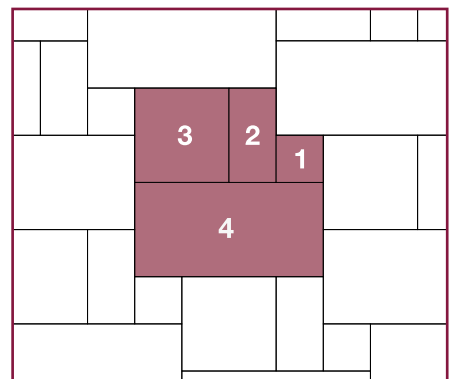
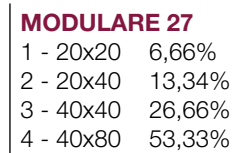
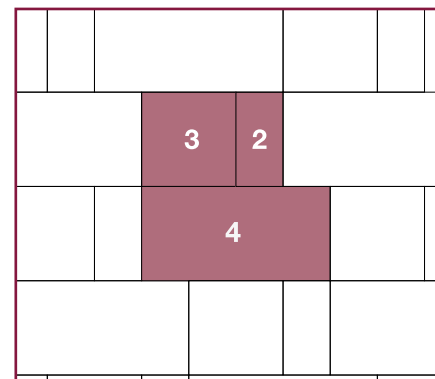
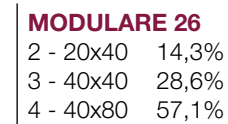
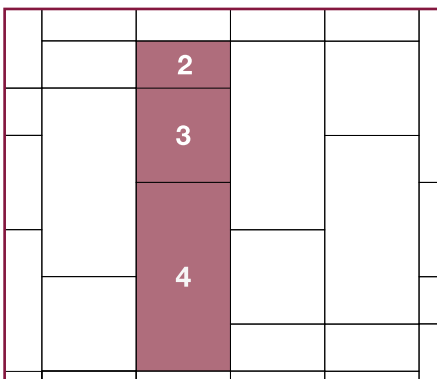
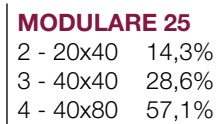
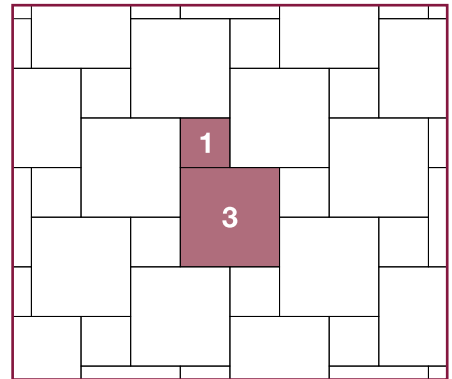
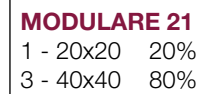
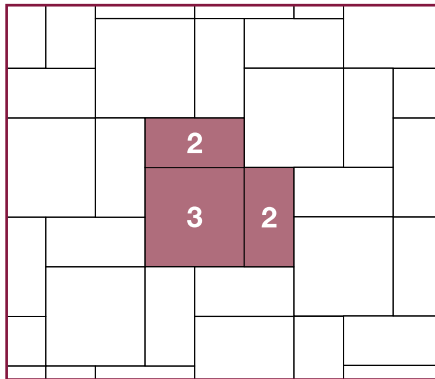
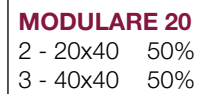
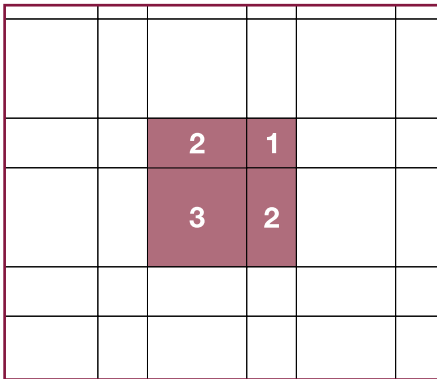
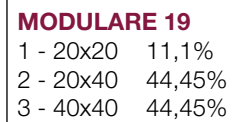
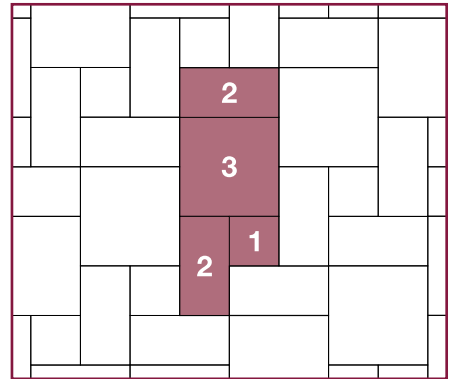
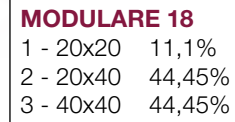
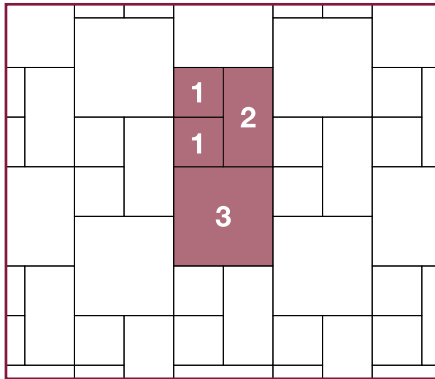
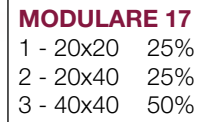
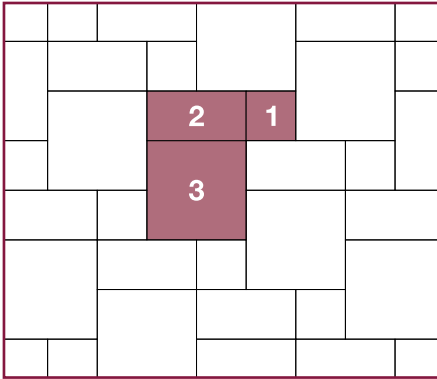
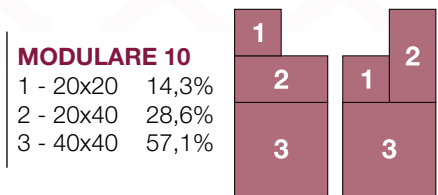

CARATTERISTICHE TECNICHE GRES FINE PORCELLANATO SMALTATO CIR - ISO 13006 Bla GL TECHNICAL FEATURES CIR GLAZED FINE PORCELAIN STONWARE - ISO 13006 Bla GL - CARACTÉRISTIQUES TECHNIQUES GRÉS CÉRAME FIN ÉMAILLÉ CIR - ISO 13006 Bla GL TECHNISCHE EIGENSCHAFTEN CIR GLASIERTES FEINSTEINZEUG - ISO 13006 Bla GL - ТЕХНИЧЕСКИЕ ХАРАКТЕРИСТИКИ ТОНКОГО ГЛАЗУРОВАННОГО ФАРФОРОВОГО КЕРАМОГРАНИТА CIR - ISO 13006 Bla GL			
	Proprietà fisico-chimiche Physical chemical properties / Propriétés physico chimiques Physisch chemische Eigenschaften / Физико химические свойства	Metodo di prova Standard of test / Norme du test Testnorm / Метод испытания	Valore medio Mean value / Valeur moyenne Mittelwert / Среднее значение
	Dimensioni Dimensions Dimensions Abmessungen Размеры		
	Lunghezza e larghezza Length and width Longueur et largeur Länge und Breite Длина и ширина	W 10 test	$\pm 0,6\% \text{ max}$ $\pm 0,5\% \text{ max}$
	Spessore Thickness Epaisseur Stärke Толщина	ISO 10545 - 2	$\pm 5\% \text{ max}$
	Rettilineità degli spigoli Straightness of sides Rectitude des arêtes Kantengeradheit Прямолинейность кромок		$\pm 0,5\% \text{ max}$
	Ortogonalità Rectangularity Orthogonalité Rechtwinkigkeit Ортогональность		$\pm 0,6\% \text{ max}$
	Planarità Surface flatness Planéité Ebenförmigkeit Плоскостность	ISO 10545-2 ASTM C 485	$\pm 0,5\% \text{ max}$ Warpage diagonal/edge $\pm 0,4\%$
	Variazioni di tono Shade variations Variations de nuance Tonvariationen Вариация оттенка		[V4] FORTE STONALIZZAZIONE EFFET STONAGE MARBRÉ EFFET STONAGE TRÈS ACCENTUÉ КОМБАТ ПРЯМОУГОЛЬНИК
	Assorbimento d'acqua Water absorption Absorption d'eau Wasseraufnahme Водопоглощение	ISO 10545 - 3	10x10: $0,5\% < E \leq 3\%$ Blb GL
	Resistenza al gelo Frost resistance Résistance au gel Frostbeständigkeit Морозостойкость	ISO 10545 - 12	Ingelivo Frost proof Résistant au gel Frosticher Морозостойкий
	Resistenza agli sbalzi termici Resistance to thermal shock Résistance aux écarts de température Temperaturwechselbeständigkeit Стойкость к тепловым перепадам	ISO 10545 - 9	Résistente Resistant Widerstandsfähig Устойчивый
	Resistenza al cavillo di piastrelle smaltate Cracking resistance of glazed tiles Résistance à la tréssillure des carreaux émaillés Haarrißbeständigkeit der glasierten Fliesen Стойкость глазурованной плитки к кракелюру	ISO 10545 - 11	Résistente Resistant Widerstandsfähig Устойчивый
	Resistenza della superficie (scala MOHS) Scratch hardness (MOHS scale) Dureté de la surface (échelle MOHS) Oberflächenhärte (MOHS skala) Поверхностная прочность по (шкале Мооса)	EN 101	Mohs 8
	Resistenza alla abrasione della superficie di piastrelle smaltate Resistance to surface abrasion of glazed tiles Résistance à l'abrasion de la surface des carreaux émaillés Widerstand gegen Abrieb der Oberfläche der glasierten Fliesen Стойкость глазурованной плитки к поверхностному истиранию	ISO 10545 - 7	Classe 4 Class 4 Classe 4 Gruppe 4 Класс 4
	Resistenza ai prodotti chimici di uso domestico Resistance to household chemicals Résistance aux produits chimiques ménagers Widerstand gegen Haushaltsreiniger Стойкость к бытовым химикатам	ISO 10545 - 13	Classe GA Class GA Classe GA Gruppe GA Класс GA
	Resistenza agli acidi e alle basi a bassa concentrazione Resistance to low concentrations of acids and bases Résistance aux acides et aux bases à faible concentration Widerstand gegen schwach konzentrierten Säuren und Laugen Стойкость к низкоконцентрированным кислотам и щелочам		Classe GLA Class GLA Classe GLA Gruppe GLA Класс GLA
	Resistenza alle macchie di piastrelle smaltate Resistance to stains of glazed tiles Résistance aux taches des carreaux émaillés Widerstand gegen Fleckenbildner der glasierten Fliesen Стойкость глазурованной плитки к образованию пятен	ISO 10545 - 14	Classe 5 Class 5 Classe 5 Gruppe 5 Класс 5
	Resistenza alla flessione Resistance to flexion Résistance à la flexion Biegezugfestigkeit Прочность на изгиб	Modulo di rottura - Modulus of rupture Module de rupture - Bruchmodul - Модуль жесткости Carico di rottura - Breaking of rupture Charge de rupture - Bruchkraft - Сфкшксшщ кщеекф	ISO 10545 - 4 $IR \geq 32 \text{ N/mm}^2$ $S \geq 1300 \text{ N}$
		DIN 51130	R10 - R11
		DIN 51097	Classe C Class C Classe C Gruppe C Класс C
	Caratteristiche antiscivolo Anti-slip properties Caractéristiques antidérapantes Rutschhemmende Eigenschaft Характеристики устойчивости к скольжению	B.C.R.A. REP. CEC. 6/81	R10: $\mu \geq 0,40$ R11: $\mu \geq 0,74$
		ASTM C 1028	R11: DRY: $\mu > 0,70$ - WET: $\mu > 0,70$ R10: DRY: $\mu > 0,70$ - WET: $\mu > 0,60$
		DCOF	$\mu > 0,42$

Prova eseguita su: 20x20 cm e 20x20 cm waikiki / Test carried out on: 20x20 cm end 20x20 cm waikiki / Essai effectué sur: 20x20 cm et 20x20 cm waikiki / Getestet auf: 20x20 cm und 20x20 cm waikiki
 Испытание произведено на: 20x20 см и Waikiki 20x20 см



Per informazioni relative ai dati tecnici su marcatura CE vedere il sito www.cir.it
 Please refer to our web site www.cir.it for technical information related to CE labeling
 Pour tout renseignement sur l'étiquetage technique de la marque CE veuillez consulter le site www.cir.it
 Informationen bezüglich technischer Daten zur Beschriftung CE entnehmen Sie unserer Website www.cir.it
 Технические данные маркировки ЕС смотреть сайт www.cir.it

Terzo Edizione: Marzo 2014

PROGETTO: Omniadvert

COORDINAMENTO: Ufficio Marketing Cir

FOTO: Foto Mussatti

FOTOELABORAZIONI: Ufficio Marketing Cir - Digital Design

STAMPA: Arbe Industrie Grafiche

CREDITS: Arredo bagno Cerasa - www.cerasa.it

Arredamento Agora Forme d'arredo - www.agorasrl.biz

© Copyright 2014 Serenissima Cir Industrie Ceramiche S.p.A. (Società Unipersonale)

Thank to:



Ceramics of Italy



SERENISSIMA CIR S.p.A.
INDUSTRIE  CERAMICHE 



sponsor **BOLOGNA F.C. 1909**

Ceramica Cir

Via A. Volta 23/25 - 42013 Casalgrande (RE) Italy
Tel. +39-0522-998911 - Fax Italy +39-0522-998910 - Fax Export +39-0522-998930
www.cir.it - e-mail: cir@cir.it - e-mail Italy: italia@cir.it - e-mail Export: export@cir.it

Serenissima Cir Industrie Ceramiche spa
Società Unipersonale
www.serenissimacir.com

DAL 1969