

THG[®]

P A R I S

Design

LALIQUE  *Daum*   BERNARDAUD
CREATIONS
Jean-Claude ESTEYNE
PARIS ALBERTO PINTO Pierre-Yves
ROCHON

 JAMIE DRAKE *Chantal Thomass* OLIVIER GAGNERE 
PARIS ogossart



THG®
P A R I S

Design

UN SAVOIR-FAIRE UNIQUE / A unique know-how

Einzigartiges Know-How 2

RÉFÉRENCES / Project references / Unsere Referenzen 4

Esprit Boutique

■ DAUM	8
■ LALIQUE	22
■ BERNARDAUD	42
■ OLIVIER GAGNÈRE	52
■ CHANTAL THOMASS	60
■ PRESTIGE	64

Les Essentielles

■ OLIVIER GOSSART	80
■ ALBERTO PINTO	86
■ JAMIE DRAKE	96
■ PIERRE-YVES ROCHON	102
■ CONTEMPORAINE	110
■ TRADITIONNELLE	120
■ INTEMPORELLE	136
■ BAROQUE	154
■ CASCADE	166
■ SKY SHOWERS	172
■ HYDROMASSAGE	173
■ VASQUES MÉTAL / Metal basins / Waschbecken	174
■ ACCESSOIRES / Accessories / Accessoires	175

LALIQUE



Daum

AP
ALBERTO PINTO

PYR
Pierre-Yves
ROCHON

BERNARDAUD

■ JAMIE DRAKE

Chantal Thomass
PARIS

OLIVIER GAGNÈRE

O.
ogossart



“THG démontre en permanence ses capacités d’adaptation et ses possibilités de développement de produits spécifiques”

N’hésitez pas à nous consulter...

THG offers a wide range of models. However, if you have specific requests or needs we are able to answer them. Don't hesitate to ask us...

THG bietet eine breite Auswahl an verschiedenen Modellen. Wenn Sie jedoch besondere Wünsche oder Vorstellungen haben, können wir selbstverständlich auch diesen gerecht werden. Wir stehen Ihnen jederzeit gerne zur Verfügung.

Un savoir-faire unique

A unique know-how

Einzigartiges Know-How



L'entreprise maîtrise tous les corps de métier, tous les savoir-faire qui interviennent dans la fabrication d'une robinetterie, d'un accessoire. La meilleure démonstration serait d'avoir un produit THG entre les mains. Finition, assemblage et générosité des matières parlent d'eux-mêmes. Tout concourt à vous faire comprendre que vous êtes en présence d'un produit d'exception, qui le restera au fil du temps.

La qualité des produits THG est le résultat de toute la politique de l'entreprise, dont voici les points essentiels :

- Plus de 10 métiers intégrés. Bureau d'études, outillage, fonderie, usinage, polissage, traitement de surface (respect de l'environnement : aucun rejet), assemblage...
- Compétence individuelle des hommes associée à la haute technologie (robots polisseurs, tours numériques...)
- Une grande largeur de gamme
- Savoir-faire reconnu dans le monde entier.

The company is master of all trades, with all of the know-how involved in the manufacture of a valve or tap or accessory. The best demonstration would be to hold a THG product in one's hand. Finish, assembly and generosity of raw materials all speak for themselves. Everything conspires to make you believe that you are in the presence of an exceptional product, and one that will remain so through the years.

The quality of THG products is the result of every aspect of THG company policy, the essential points of which are as follows:

- *More than 10 trades incorporated into the product. Design, Research & Development, tooling, foundry, machining, polishing, plating (environment friendly: no refusal), assembly...*
- *The alliance of a craft know-how with modern equipment (polishing robots, N.C. drilling and threading machines...)*
- *Unequalled depth of range of elegant bathroom fittings.*
- *THG's know-how is recognised throughout the world.*

Das Unternehmen besitzt ein umfassendes Fachwissen in allen Fertigungsbereichen und das zur Herstellung von Armaturen und Accessoires erforderliche technische Know-how. Die Qualität ließe sich am einfachsten erklären, wenn Sie ein THG-Produkt in den eigenen Händen hielten. Oberflächenbearbeitung, Montage und Material sprechen für sich. Sie sehen und fühlen sofort, dass Sie ein außergewöhnlich-hochwertiges Produkt vor sich haben, das jahrelang einwandfrei funktionieren wird.

Diese Qualität aller THG Produkte ist das Ergebnis der gesamten Unternehmenspolitik von THG, die sich in folgenden Punkten zusammenfassen lässt:

- Mehr als 10 Berufe in der Herstellung, Gießerei, Bearbeitung, Polierung, Oberflächenbehandlung (schadstofflos und somit umweltfreundlich), Montage, im Planungsbüro und Werkzeugbau...
- Fachkompetenz aller Mitarbeiter/-innen im Umgang mit den hochtechnisierten Produktionsanlagen (wie z.B. Polierroboter, NC-Drehmaschinen...).
- Unübertroffen breite Produktpalette.
- Weltweit anerkanntes Know-how.



1. Intercontinental (Paris)
2. Le Ritz (Paris)
3. Scribe (Paris)
4. Fouquet's (Paris)
5. Monte Carlo Bay (Monaco)
6. Shangri La (Paris)

Références

Project references
Unsere Referenzen



Partout où esthétique et raffinement se conjuguent au quotidien, THG apporte aux hommes les clefs d'un paradis retrouvé.

Everywhere where beauty and refinement combine daily, THG provide people with the keys of a rediscovered paradise.

Überall dort, wo sich Funktion und Ästhetik vereinen, gibt THG den Menschen den Schlüssel für dieses wiederentdeckte Paradies.

1. Amnesia - 2. Squall - 3. Delphine



1
2
3
4

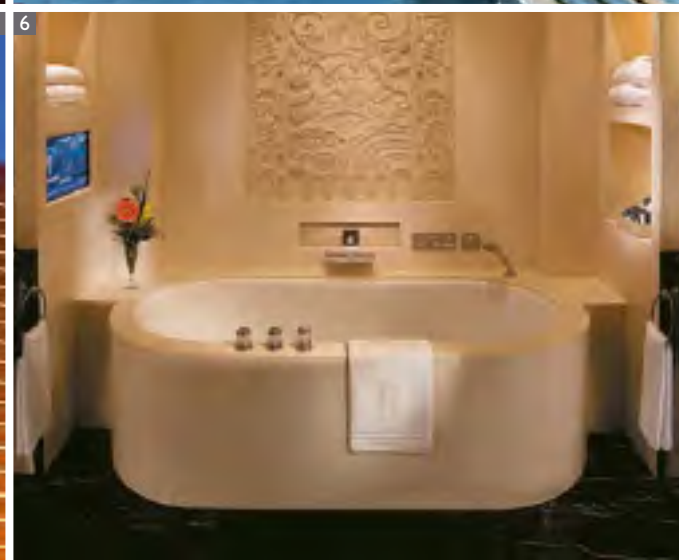
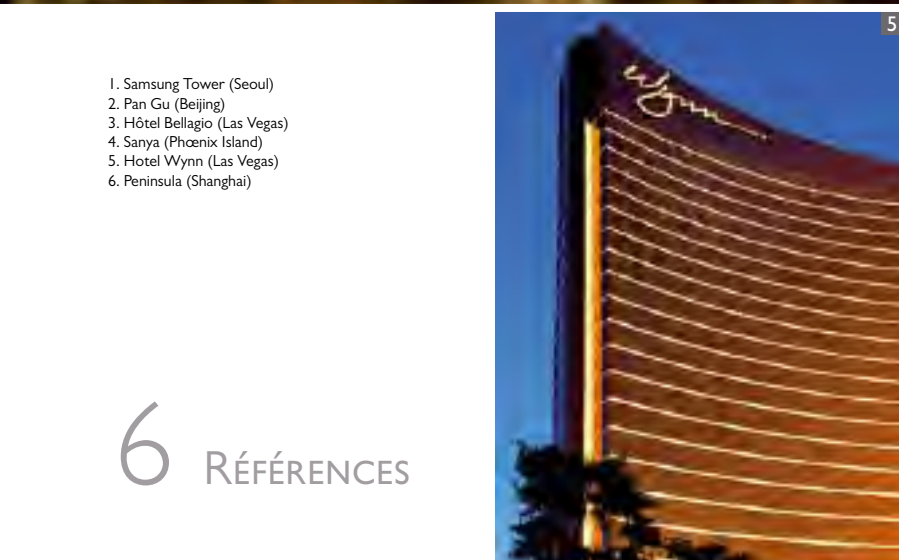

1. Samsung Tower (Seoul)
2. Pan Gu (Beijing)
3. Hôtel Bellagio (Las Vegas)
4. Sanya (Phoenix Island)
5. Hotel Wynn (Las Vegas)
6. Peninsula (Shanghai)

Références

Project references
Unsere Referenzen

Des références prestigieuses aux quatre coins du monde...

Prestigious references everywhere in the world...

Glanzvolle Verweise überall in der Welt...



1. Hôtel Burj Al Arab (Dubai) - 2. Emirates Palace (Abu Dhabi)





Collection Daum

Daum, maître-verrier légendaire, entretient depuis plus d'un siècle une relation d'amour avec les plus grands artistes de son temps. Si la technique de la pâte de verre existe depuis l'Antiquité, Daum la redécouvre en 1968 en la retravaillant avec du cristal. Ainsi, Daum a associé son savoir-faire à celui de THG, fabricant français de robinetterie de luxe, pour créer une collection inédite.

Daum, the legendary glassmaker master, has kept alive for more than a century a love relationship with the greatest artists of its time. Although the "pâte de verre" technique has existed since Antiquity, Daum rediscovered it in 1968 when it invented a method of reworking it using crystal. Thus, Daum has combined its expertise to THG's, the famous French fittings manufacturer, to present a brand new collection of luxurious taps.

Vor mehr als einem Jahrhundert begann der legendäre Glasmeister Daum, Beziehungen zu den größten Künstlern seiner Zeit aufzubauen. Die Technik der Glaspaste ist zwar bereits seit der Antike bekannt, Daum hat sie jedoch 1968 in der Verbindung mit Kristall regelrecht neu entdeckt. Mit vereintem Know-how haben Daum und der französische Hersteller von Luxusarmaturen THG eine Kollektion ohnegleichen geschaffen.





Ref. U5G.151

Mélangeur de lavabo 3 trous - Moon Dragon
 Rim mounted 3-hole basin mixer - Moon Dragon
 3-Loch-Waschtischbatterie - Moon Dragon



Ref. U5H.151

Mélangeur de lavabo 3 trous - Jade Dragon
 Rim mounted 3-hole basin mixer - Jade Dragon
 3-Loch-Waschtischbatterie - Jade Dragon



Ref. U5D.5500B

Garniture pour mitigeur thermostatique
 avec inverseur 2 sorties
 Trim for THG thermostat
 with 2-way diverter
 Thermostat-Garnitur
 mit Temperatureinstellung mit Absperr- und
 Umstellfunktion

Dragon

design 
CREATIONS
Jean-Claude DELFÈRE
PARIS

Sun / Moon / Jade



Ref. USD.151

Mélangeur de lavabo 3 trous - Sun Dragon
Rim mounted 3-hole basin mixer - Sun Dragon
3-Loch-Waschtischbatterie - Sun Dragon



Ref. USD.514

Porte-serviette L 700 mm
Single towel rail L 700 mm / 27 1/2"
Handtuchstange L 700 mm



12 *Daum*

Flore

design

CREATIONS
Jean-Claude DELZENNE
PARIS



Ref. USA.504N

Anneau porte-serviette Ø 180 mm
Single towel ring Ø 180 mm / 7"
Handtuchring Ø 180 mm



Ref. USA.151

Mélangeur de lavabo 3 trous
Rim mounted 3-hole basin mixer
3-Loch-Waschtischbatterie



Paradise

design 
CREATONS
Journé Grande DÉCOUPE
PARIS



Ref. USC.151

Mélangeur de lavabo 3 trous
Rim mounted 3-hole basin mixer
3-Loch-Waschtischbatterie



Ref. USC.536

Porte-verre mural
Wall mounted tumbler
Wandglashalter mit Glas





Ref. U5B.500

Porte-savon mural
Wall mounted soap dish
Seifenschale zur Wandmontage



Ref. U5B.151

Mélangeur de lavabo 3 trous
Rim mounted 3-hole basin mixer
3-Loch-Waschtischbatterie

Vegetal

design 
CREATIONS
Jewelry - Watches - CLOCKS
PARIS



18 *Daum*



Ref. U5F.517
Porte-peignoir
Single robe hook
Bademantelhaken



Ref. U5F.5100B
Garniture pour mitigeur thermostatique
Trimmings for THG thermostat
Thermostat-Garnitur



Ref. U5F.151
Mélangeur de lavabo 3 trous
Rim mounted 3-hole basin mixer
3-Loch-Waschtischbatterie



20 Daum

Ginkgo

design

CREATIONS
Avenue Charles de Gaulle 92000
NANTERRE
FRANCE



Ref. USE.151

Mélangeur de lavabo 3 trous
Rim mounted 3-hole basin mixer
3-Loch-Waschtischbatterie

Ref. USE.538AC

Porte-papier
Wall mounted WC paper holder
WC-Papierhalter







Collection LALIQUE

Depuis 2002, JCD Créations, célèbre robinetier de style français et LALIQUE, manufacture emblématique d'objets en cristal, ont uni leurs savoir-faire respectifs afin de proposer une gamme luxueuse et raffinée de robinetteries, d'accessoires, de boutons de meuble et de poignées de porte.

Since 2002, JCD Creations, renowned French fittings manufacturer and LALIQUE the symbolic factory for crystal items, have combined their expertise to offer a luxurious and refined range of fittings, accessories, cabinet knobs and door handles.

Seit 2002 entwickeln der renommierte Armaturenhersteller aus Frankreich, THG Paris, und Lalique, das Sinnbild für Kristallerzeugnisse, mit ihrem Fachwissen luxuriöse und veredelte Kollektionen von JCD Créations Jean Claude Delépine: Armaturen, Accessoires sowie Schrank- und Türgriffe.



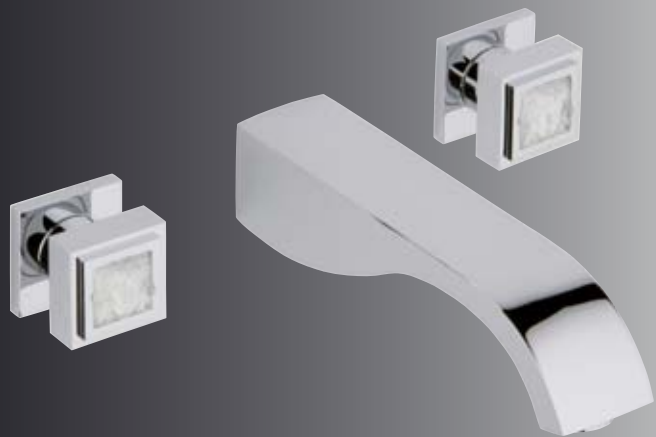

Ref. A2U.20G

Mélangeur de bain 3 trous mural
 Wall mounted 3-hole bath mixer
 3-Loch-Wannenfüllbatterie zur Wandmontage



Ref. A2U.514

Porte-serviette L 700 mm
 Single towel rail L 700 mm / 27 1/2"
 Handtuchstange 700 mm



Ref. A2U.536

Porte-verre mural
 Wall mounted tumbler
 Wandglashalter mit Glas



Ref. A2U.151

Mélangeur de lavabo 3 trous - Métal lisse
 Rim mounted 3-hole basin mixer - Smooth metal
 3-Loch-Waschtischbatterie - Glattes Metall

Masque de femme

métal lisse / métal gravé

design

CREATIONS
Jean-Claude LALIQUE
1948



Ref. A2T.151

Mélangeur de lavabo 3 trous - Métal gravé
Rim mounted 3-hole basin mixer - Engraved metal
3-Loch-Waschtischbatterie - Graviertes Metall

Masque de femme

solaire / lunaire

design

CREATIONS
Jean-Claude LALIQUE
1982



Ref. A2S.151

Mélangeur de lavabo 3 trous - Décor solaire
Rim mounted 3-hole basin mixer - "Solaire" decor
3-Loch-Waschtischbatterie - «Solaire» Dekor



Ref. A2R.280C

Pomme de douche 300 x 300 mm
Shower head 300 x 300 mm / 11 3/4" x 11 3/4"
Brausekopf 300 x 300 mm



Ref. A2R.5100B

Garniture pour mitigeur thermostatique
Trimings for thermostat
Thermostat-Garnitur



Ref. A2R.504N

Anneau porte-serviette Ø 180 mm
Single towel ring Ø 180 mm / 7"
Handtuchring Ø 180 mm



Ref. A2R.151

Mélangeur de lavabo 3 trous - Décor lunaire
Rim mounted 3-hole basin mixer - "Lunaire" decor
3-Loch-Waschtischbatterie - «Lunaire» Dekor



Ref. A2Y.151

Mélangeur de lavabo 3 trous - Cristal Soleil / améthyste
Rim mounted 3-hole basin mixer - Sun crystal / amethyst
3-Loch-Waschtischbatterie - Kristall Soleil / Amethyst



Ref. A2P.151

Mélangeur de lavabo 3 trous - Cristal soleil
Rim mounted 3-hole basin mixer - Sun crystal
3-Loch-Waschtischbatterie - Kristall Soleil



Ref. A2N.151

Mélangeur de lavabo 3 trous - Cristal clair
Rim mounted 3-hole basin mixer - Clear crystal
3-Loch-Waschtischbatterie - Klarer Kristall

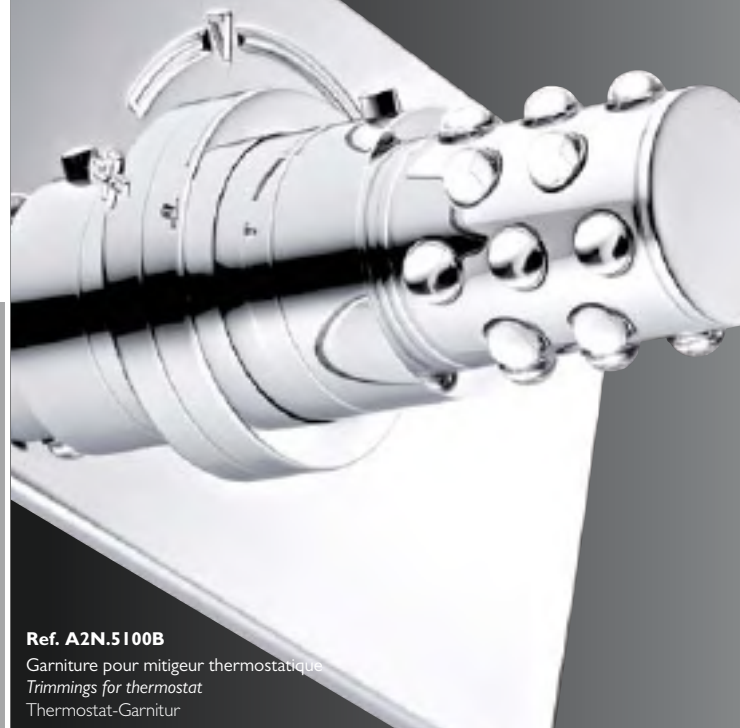

Ref. A2N.5100B

Garniture pour mitigeur thermostatique
Trimings for thermostat
Thermostat-Garnitur



Ref. A2N.544GM

Coupe à poser Ø 150 mm
Soap dish on stand Ø 150 mm / 6"
Standseifenschale Ø 150 mm



Ref. A2W.151

Mélangeur de lavabo 3 trous - Cristal clair / onyx noir
Rim mounted 3-hole basin mixer - Clear crystal / black onyx
3-Loch-Waschtischbatterie - Klarer Kristall / Schwarzer Onyx

Bambou

design

CREATIONS
Journé - Châtelain 1872/2012
71625



Ref. A33.151

Mélangeur de lavabo 3 trous - Cristal noir
Rim mounted 3-hole basin mixer - Black crystal
3-Loch-Waschtischbatterie - Schwarzer Kristall



Ref. A35.6500

Mitigeur de lavabo - Cristal clair
Single lever basin mixer - Clear crystal
Waschtisch-Einhebelmischer - Klarer Kristall



Ref. A35.151

Mélangeur de lavabo 3 trous - Cristal clair
Rim mounted 3-hole basin mixer - Clear crystal
3-Loch-Waschtischbatterie - Klarer Kristall



Ref. A35.504N

Anneau porte-serviette Ø 180 mm
Single towel ring Ø 180 mm / 7"
Handtuchring Ø 180 mm

Ref. A34.151

Mélangeur de lavabo 3 trous - Cristal ambre
Rim mounted 3-hole basin mixer - Amber crystal
3-Loch-Waschtischbatterie - Bernsteinfarbenes Kristall





Ref. A2H.546GM

Coupe murale Ø 150 mm - Cristal clair
Wall mounted soap dish Ø 150 mm / 6" - Clear crystal
Wandseifenschale Ø 150 mm - Klarer Kristall



Ref. A2H.504N

Anneau-porte serviette Ø 180 mm - Cristal clair
Single towel ring Ø 180 mm / 7" - Clear crystal
Handtuchring Ø 180 mm - Klarer Kristall



Panthère

design

CREATIONS
Jewelry - Crystal - 1852/1916
PARIS



Ref. A2H.151

Mélangeur de lavabo 3 trous - Cristal clair
Rim mounted 3-hole basin mixer - Clear crystal
3-Loch-Waschtischbatterie - Klarer Kristall

Ref. A2K.151

Mélangeur de lavabo 3 trous - Cristal noir
Rim mounted 3-hole basin mixer - Black crystal
3-Loch-Waschtischbatterie - Schwarzer Kristall

LALIQUE 33



Ref. A2A.504N

Anneau-porte serviette Ø 180 mm - Cristal clair
Single towel ring Ø 180 mm / 7" - Clear crystal
Handtuchring Ø 180 mm - Klarer Kristall



Ref. A2L.620

Porte-savon fil mural - Cristal noir
Net soap dish - Black crystal
Wandseifenkorb - Schwarzer Kristall



Ref. A2A.151

Mélangeur de lavabo 3 trous - Cristal clair
Rim mounted 3-hole basin mixer - Clear crystal
3-Loch-Waschtischbatterie - Klarer Kristall



Ref. A2L.151

Mélangeur de lavabo 3 trous - Cristal noir
Rim mounted 3-hole basin mixer - Black crystal
3-Loch-Waschtischbatterie - Schwarzer Kristall



Métropolis

design 
CREATIONS
Since 1988





Profil

design

crystal

by



JAMIE
DRAKE

CREATIONS
JEWELRY DESIGNER
PARIS

Ref. A6G.151

Mélangeur de lavabo 3 trous - Cristal clair
Rim mounted 3-hole basin mixer - Clear crystal
3-Loch-Waschtischbatterie - Klarer Kristall



Ref. A6M.151

Mélangeur de lavabo 3 trous - Cristal noir
Rim mounted 3-hole basin mixer - Black crystal
3-Loch-Waschtischbatterie - Schwarzer Kristall



Ref. A6H.151

Mélangeur de lavabo 3 trous - Cristal clair
Rim mounted 3-hole basin mixer - Clear crystal
3-Loch-Waschtischbatterie - Klarer Kristall



Ref. A6L.151

Mélangeur de lavabo 3 trous - Cristal noir
Rim mounted 3-hole basin mixer - Black crystal
3-Loch-Waschtischmischerie - Schwarzer Kristall

LALIQUE 37

Papillon

design 
CREATIONS
Jewelry - Crystal - 1812/2012
1888



Ref. A2J.514

Porte-serviette L 700 mm
Single towel rail L 700 mm / 27 1/2"
Handtuchstange 700 mm



Ref. A2J.151

Mélangeur de lavabo 3 trous
Rim mounted 3-hole basin mixer
3-Loch-Waschtischbatterie

LALIQUE 39



40 LALIQUE



Ref. A2C.20GA

Mélangeur de lavabo 3 trous mural
Wall mounted 3-hole basin mixer
3-Loch-Waschtischbatterie zur Wandmontage



Ref. A2C.15I

Mélangeur de lavabo 3 trous
Rim mounted 3-hole basin mixer
3-Loch-Waschtischbatterie



Ref. A2C.514

Porte-serviette L 700 mm
Single towel rail L 700 mm / 27 1/2"
Handtuchstange 700 mm

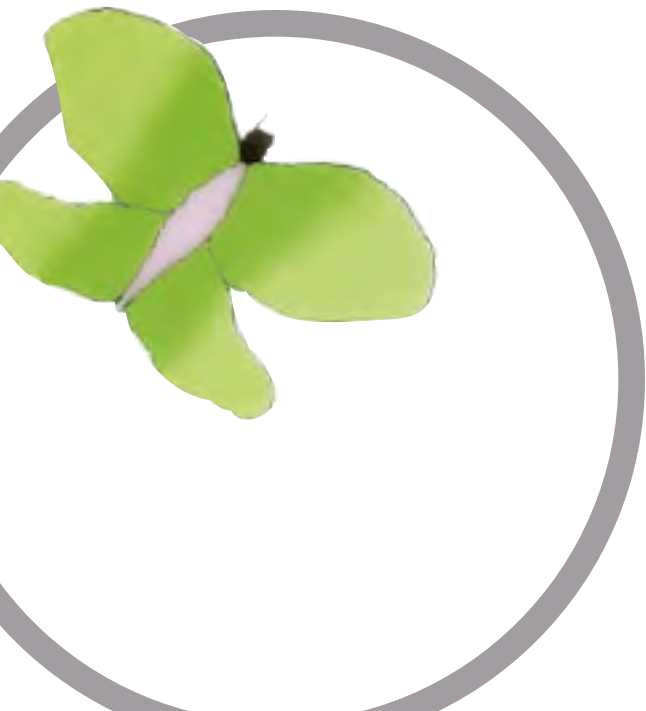
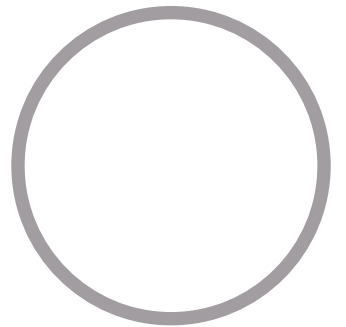
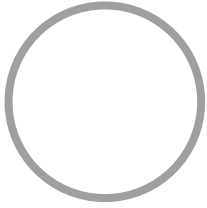



Collection BERNARDAUD

Née d'un savoir-faire artisanal profondément ancré dans la tradition française, l'alliance JCD Créations et Bernardaud célèbre le luxe sous toutes les formes d'un art sans cesse renouvelé.

The result of craft expertise profoundly steeped in French tradition, the alliance of JCD Créations and Bernardaud celebrates luxury in all its forms with constantly renewed artistry.

Das Bündnis zwischen JCD Créations und Bernardaud gründet auf einem tief in der französischen Tradition verwurzelten handwerklichen Können und steht im Zeichen einer neuen Kunst in all ihren Formen.



Capucine

design

 CREATIONS
 Avenue Charles BERNARDAUD
 PARIS



Ref. A7E.151

Mélangeur de lavabo 3 trous
Rim mounted 3-hole basin mixer
 3-Loch-Waschtischbatterie



Ref. A7E.3202

Mélangeur de bidet monotrou à rotule
One-hole bidet mixer swivel jet
 1-Loch-Zweigriff-Bidetbatterie



Ref. A7E.112BSG

Mélangeur bain-douche 4 trous
Rim mounted 4-hole bath shower mixer
 4-Loch-Wannenfüll-und Brausebatterie



Ref. A7E.504N

Anneau-porte serviette Ø 180 mm
Single towel ring Ø 180 mm / 7"
 Handtuchring Ø 180 mm



Ref. A7E.546GM

Coupe murale Ø 150 mm
Wall mounted soap dish Ø 150 mm / 6"
 Wandseifenschale Ø 150 mm



Ref. A7E.4611

Pot avec couvercle
Jar with cover
 Dose mit Deckel



Ref. A7E.4609

Vase cylindrique
Vase
 Zylindrische Vase



Ref. A7E.4610

Pot à pinceaux
Make-up paintbrush pot
 Schminkepinsel-Box



Ref. A7E.4608

Verre à dent
Cup
 Zahnbecher



Ref. A7E.4618

Bougeoir suédois
Sweden candle-holder
 Schwedischer Kerzenleuchter



Ref. A7E.4616

Boîte à pilules ronde
Round pills box
 Runde Box



Ref. A7E.4617

Boîte à pilules carrée
Square pills box
 Quadratische Box



Ref. A7D.151
Mélangeur de lavabo 3 trous
Rim mounted 3-hole basin mixer
3-Loch-Waschtischbatterie



Ref. A7D.536
Porte-verre mural
Wall mounted tumbler
Wandglashalter mit Glas



Ref. A7D.20SG
Mélangeur de bain mural 3 trous
Wall mounted 3-hole bath mixer
3-Loch-Wannenfüllbatterie zur Wandmontage



Ref. A7D.514/ 50
Porte-serviette L 500 mm
Single towel rail L 500 mm / 20"
Handtuchstange 500 mm



Ref. A7D.4614
Plateau 22x20 cm
Tray 22x20 cm / 8 3/4"x8"
Flache Schale 22x20 cm

Ref. A7D.4613
Plateau 17x15 cm
Tray 17x15 cm / 6 3/4"x6"
Flache Schale 17x15 cm

Ref. A7D.4612
Plateau 12x11 cm
Tray 12x11 cm / 4 3/4"x4 3/4"
Flache Schale 12x11 cm



Ref. A7D.4615
Coupelle Ø13 cm
Dish, Ø13 cm / 5"
Schale Ø13 cm



Ref. A7D.4619
Boîte petit modèle
Box, small size
Dose kleines Modell



Ref. A7D.4621
Boîte moyen modèle
Box, middle size
Dose, mittelgroßes Modell



Ref. A7D.4623
Boîte grand modèle
Box, big size
Dose, großes Modell



Ref. A7A.4611
Pot avec couvercle
Jar with cover
Dose mit Deckel



Ref. A7A.4609
Vase cylindrique
Vase
Zylindrische Vase



Ref. A7A.4607
Porte-savon
Soap dish
Seifenschale



Ref. A7A.4608
Verre à dent
Cup
Zahnbecher



Ref. A7A.4618
Bougeoir suédois
Sweden candle-holder
Schwedischer Kerzenleuchter



Ref. A7A.4616
Boîte à pilules ronde
Round pills box
Runde Box



Ref. A7A.4617
Boîte à pilules carrée
Square pills box
Quadratische Box

Ithaque

design 
CREATIONS
Journées de la Céramique 1982-1998
Paris



Ref. A7A.151

Mélangeur de lavabo 3 trous
Rim mounted 3-hole basin mixer
3-Loch-Waschtischbatterie



Ref. A7B.151

Mélangeur de lavabo 3 trous
Rim mounted 3-hole basin mixer
3-Loch-Waschtischbatterie

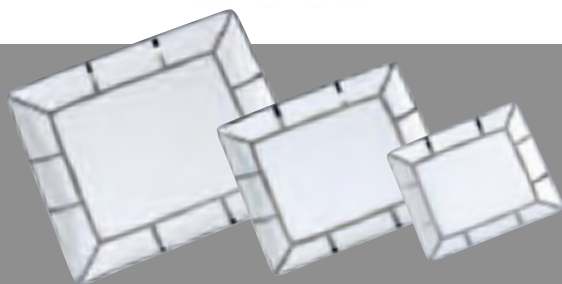

Ref. A7B.4614

Plateau 22x20 cm
Tray 22x20 cm / 8 3/4" x 8"
Flache Schale 22x20 cm

Ref. A7B.4613

Plateau 17x15 cm
Tray 17x15 cm / 6 3/4" x 6"
Flache Schale 17x15 cm

Ref. A7B.4612

Plateau 12x11 cm
Tray 12x11 cm / 4 3/4" x 4 3/4"
Flache Schale 12x11 cm



Ref. A7B.4615

Coupelle Ø13 cm
Dish, Ø13 cm / 5"
Schale Ø 13 cm



Ref. A7B.4619

Boîte petit modèle
Box, small size
Dose kleines Modell



Ref. A7B.4621

Boîte moyen modèle
Box, middle size
Dose, mittelgroßes Modell



Ref. A7B.4623

Boîte grand modèle
Box, big size
Dose, großes Modell



Ref. A7G.151
 Mélangeur de lavabo 3 trous
Rim mounted 3-hole basin mixer
 3-Loch-Waschtischbatterie



Ref. A7G.4611
 Pot avec couvercle
Jar with cover
 Dose mit Deckel

Ref. A7G.4609
 Vase cylindrique
Vase
 Zylindrische Vase

Ref. A7G.4607
 Porte-savon
Soap dish
 Seifenschale

Ref. A7G.4608
 Verre à dent
Cup
 Zahnbecher

Ref. A7G.4618
 Bougeoir suédois
Sweden candle-holder
 Schwedischer Kerzenleuchter

Ref. A7G.4616
 Boîte à pilules ronde
Round pills box
 Runde Box

Ref. A7G.4617
 Boîte à pilules carrée
Square pills box
 Quadratische Box



Ref. A7F.20GA
 Mélangeur de lavabo 3 trous mural
 Wall mounted 3-hole basin mixer
 3-Loch-Waschtischbatterie zur Wandmontage



Ref. A7F.3202
 Mélangeur de bidet monotrou à rotule
 One-hole bidet mixer swivel jet
 1-Loch-Zweigriff-Bidetbatterie

Ref. A7F.151
 Mélangeur de lavabo 3 trous
 Rim mounted 3-hole basin mixer
 3-Loch-Waschtischbatterie



Ref. A7F.538AC
 Porte-papier
 Wall mounted WC paper holder
 WC-Papierhalter

Ref. A7F.500
 Porte-savon mural
 Wall mounted glass soap dish
 Seifenschale zur Wandmontage



Ref. A7F.2620
 Porte-savon et porte-éponge mural
 Combined soap and sponge dish
 Wandseifenschale und Schwammkorb

Ref. A7F.4611
 Pot avec couvercle
 Jar with cover
 Dose mit Deckel

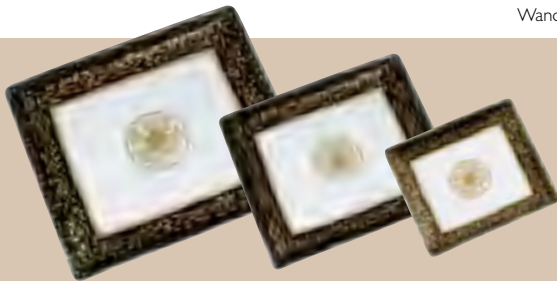

Ref. A7F.4614
 Plateau 22x20 cm
 Tray 22x20 cm / 8 3/4" x 8"
 Flache Schale 22x20 cm

Ref. A7F.4613
 Plateau 17x15 cm
 Tray 17x15 cm / 6 3/4" x 6"
 Flache Schale 17x15 cm

Ref. A7F.4612
 Plateau 12x11 cm
 Tray 12x11 cm / 4 3/4" x 4 3/8"
 Flache Schale 12x11 cm



Ref. A7F.4615
 Coupelle Ø13 cm
 Dish, Ø13 cm / 5"
 Schale Ø 13 cm



Ref. A7F.4619
 Boîte petit modèle
 Box, small size
 Dose kleines Modell



Ref. A7F.4621
 Boîte moyen modèle
 Box, middle size
 Dose, mittelgroßes Modell



Ref. A7F.4623
 Boîte grand modèle
 Box, big size
 Dose, großes Modell



Ref. A7C.6500
Mitigeur de lavabo
Single lever basin mixer
Waschtisch-Einhebelmischer



Ref. A7C.112BSG
Mélangeur bain-douche 4 trous
Rim mounted 4-hole bath-shower mixer
4-Loch-Wannenfüll- und Brausebatterie



Ref. A7C.546
Coupe murale Ø 100 mm
Wall mounted soap dish Ø 100 mm / 4"
Wandseifenschale Ø 100 mm



Ref. A7C.517
Porte-peignoir
Single robe hook
Bademantelhaken



Ref. A7C.504N
Anneau-porte serviette Ø 180 mm
Single towel ring Ø 180 mm / 7"
Handtuchring Ø 180 mm



Ref. A7B.4611
Pot avec couvercle
Jar with cover
Dose mit Deckel



Ref. A7B.4609
Vase cylindrique
Vase
Zylindrische Vase

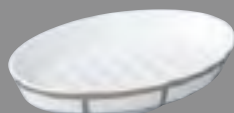

Ref. A7B.4607
Porte-savon
Soap dish
Seifenschale



Ref. A7B.4608
Verre à dent
Cup
Zahnbecher



Ref. A7B.4618
Bougeoir suédois
Sweden candle-holder
Schwedischer Kerzenleuchter



Ref. A7B.4616
Boîte à pilules ronde
Round pills box
Runde Box



Ref. A7B.4617
Boîte à pilules carrée
Square pills box
Quadratische Box



Ref. A7C.151
 Mélangeur de lavabo 3 trous
 Rim mounted 3-hole basin mixer
 3-Loch-Waschtischbatterie

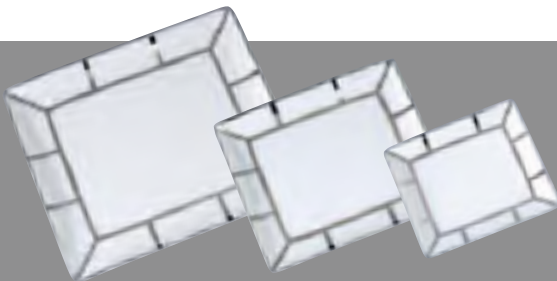

Ref. A7B.4614
 Plateau 22x20 cm
 Tray 22x20 cm / 8¾"x8"
 Flache Schale 22x20 cm

Ref. A7B.4613
 Plateau 17x15 cm
 Tray 17x15 cm / 6¾"x6"
 Flache Schale 17x15 cm

Ref. A7B.4612
 Plateau 12x11 cm
 Tray 12x11 cm / 4¾"x4¾"
 Flache Schale 12x11 cm



Ref. A7B.4615
 Coupelle Ø13 cm
 Dish, Ø13 cm / 5"
 Schale Ø 13 cm



Ref. A7B.4619
 Boîte petit modèle
 Box, small size
 Dose kleines Modell



Ref. A7B.4621
 Boîte moyen modèle
 Box, middle size
 Dose, mittelgroßes Modell



Ref. A7B.4623
 Boîte grand modèle
 Box, big size
 Dose, großes Modell



Collection

O L I V I E R G A G N E R E

Pour un designer, concevoir une série de robinetterie est indéniablement un rare exercice d'équilibre ; il y est question de style et de plaisir pour l'œil, de volupté pour la main et de technicité pour l'usage. Courbe et contre-courbe du bec s'étirent avec la douceur d'une tige de tulipe ou de celle de la cambrure d'un «stiletto» et encadrent des boutons, croisillons ou manettes, aux formes géométriques épurées, simplement habillées de cabochons en creux ou en plein. La magie des reflets du métal, la délicatesse des mélanges de matières et le savoir-faire de THG font tout le reste...

For a designer, creating a series of tap fittings is, undeniably, a fine balancing act, combining style, aesthetics and feel with the technicalities of usage. Convex and concave curves, gently elongated like a tulip stem or the shaft of a "stiletto", and framed by knobs, cross handles or levers: clean geometric shapes, simply finished with concave or solid cabochons. The magic lustre of metal and a delicate blend of materials and expertise set THG ahead of all the rest... This is my seal of approval for the "Bagatelle"!

Für einen Designer ist das Entwerfen einer Armaturensérie zweifelsohne ein seltener Balanceakt, bei dem es um das richtige Gleichgewicht geht. Hierbei geht es um Stil und Genuss für das Auge, ein Vergnügen für die Hand und eine Raffinesse der technischen Nutzung. Krümmung und Gegenkrümmung des Auslaufs fließen – dem Stiel einer Tulpe oder der Wölbung eines „Stiletto“ gleich – sanft ineinander und dienen dabei als Rahmen für Drehknöpfe, Bedienungs- oder Hebelgriffe in ihrer reinsten geometrischen Form, lediglich ausgestattet mit halb oder vollends gewölbten Cabochons. Die Magie des reflektierenden Metalls, die Feinheit der miteinander kombinierten Materialien und das Know-how von THG tun ihr Übriges... Das ist mein Rezept für „Bagatelle“!



Bagatelle

pierre noire

by

 CREATIONS
 since 1946
 PARIS

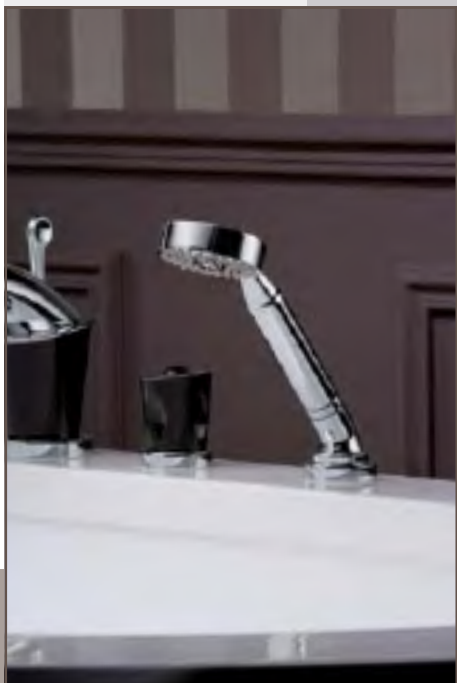

Ref. U3E.112BSG

Mélangeur bain-douche 4 trous sur gorge
Rim mounted 4-hole bath shower mixer
 4-Loch-Wannenfüll- und Brausebatterie zur Standmontage



Ref. U3E.151

Mélangeur de lavabo 3 trous
Rim mounted 3-hole basin mixer
 3-Loch-Waschtischbatterie



Ref. U3E.500B

Porte-savon mural
Wall mounted soap dish
 Seifenschale zur Wandmontage



Ref. U3F.20GA

Mélangeur de lavabo 3 trous mural
Wall mounted 3-hole basin mixer
 3-Loch-Waschtischbatterie zur Wandmontage



Ref. U3E.5100B

Garniture pour mitigeur thermostatique
Trimmings for thermostat
 Thermostat-Garnitur



Ref. U3F.151

Mélangeur de lavabo 3 trous
Rim mounted 3-hole basin mixer
 3-Loch-Waschtischbatterie

Ref. U3F.112BSG

Mélangeur bain-douche 4 trous sur gorge
Rim mounted 4-hole bath shower mixer
 4-Loch-Wannenfüll- und Brausebatterie zur Standmontage





Ref. U3C.151

Mélangeur de lavabo 3 trous
Rim mounted 3-hole basin mixer
3-Loch-Waschtischbatterie

Bagatelle by

cristal

CREATIONS
Avec Cristal DÉCOUVRE
PARIS



Ref. U3D.151
Mélangeur de lavabo 3 trous
Rim mounted 3-hole basin mixer
3-Loch-Waschtischbatterie



Ref. U3C.5400B
Garniture pour mitigeur
thermostatique avec 2 robinets d'arrêt
Trimings for thermostat with 2 valves
Thermostat-Garnitur mit 2 Absperrungen



Bagatelle métal

by

CREATIONS
Ainsi... Comme... ÉLÉGANCE
PARIS



Ref. U3A.151
Mélangeur de lavabo 3 trous
Rim mounted 3-hole basin mixer
3-Loch-Waschtischbatterie



Ref. U3A.20G
Mélangeur de bain 3 trous mural
Wall mounted 3-hole bath mixer
3-Loch-Wannenfüllbatterie
zur Wandmontage



Ref. U3B.151
Mélangeur de lavabo 3 trous
Rim mounted 3-hole basin mixer
3-Loch-Waschtischbatterie



Ref. U3A.6506
Mitigeur de lavabo
Single lever basin mixer
Waschtisch-Einhebelmischer



Ref. U3A.49/ 3VM
Inverseur 4 voies mural
avec cartouche céramique
Wall mounted diverter with ceramic cartridge
Umstellventil zur Unterputzmontage
mit Keramikelement



Love...

Lovey...

Glamour...

beautiful

Glamour...Collection

Chantal Thomass

PARIS

Egérie d'une féminité affirmée, Chantal Thomass s'intéresse à la salle de bains pour la transformer en un lieu qui lui ressemble. Les robinets donnent le ton. A la fois espiègles et glamours en porcelaine blanche Bernardaud, et avec une pointe d'impertinence, ils s'habillent d'un ruban féminin argenté. Le croisillon qui suggère la taille fine d'une femme, est surmonté d'un décor capitonné. Seul décor pour tous ces objets extrêmement raffinés, quatre mots : *Glamour, Lovely, Chic* et *Beautiful* inscrits dans une signature où les lettres à l'anglaise se marient aux entrelacs.

*The muse of assertive femininity, Chantal Thomass has turned her attention to the bathroom to transform it into a place in her image, starting with the taps. They are both playful and glamorous in their white Bernardaud porcelain, and with a touch of impertinence, they dress in a silver feminine ribbon. The cross handle, which evokes a woman's slender waist, is surmounted by a padded decoration. The only decoration on these extremely refined objects is four words: *Glamour, Lovely, Chic* and *Beautiful* ridden into a signature in which the English style lettering combines with the interlacing.*

Als Muse der bejahenden Weiblichkeit hat Chantal Thomass ihre Aufmerksamkeit nun dem Badezimmer zugewandt und es in einen Raum ihrer Vorstellung verwandelt. Mit den Wasserhähnen begann die Verwandlung: In weißem Porzellan von Bernardaud sind sie ebenso verspielt wie glamourös. Das weiblich anmutende silberfarbene Band verleiht ihnen einen Hauch von Unverfrorenheit. Der Quergriff, der an eine schmale Frauentaille erinnert, wird von einer gepolsterten Verzierung überlagert. Einziges Dekor auf diesen vollendet veredelten Stücken sind die vier Worte *Glamour, Lovely, Chic* und *Beautiful* in einer Signatur, in der die Schrift im englischen Stil und die Durchflechtung eine Einheit bilden.

Chic

Lovely...





Ref. A7L.504N

Anneau porte-serviette Ø 180 mm
Single towel ring Ø 180 mm / 7"
Handtuchring Ø 180 mm

Beautiful ...
Glamour ...

Ref. A7L.536B

Porte-verre mural
Wall mounted tumbler
Wandglashalter



Ref. A7L.500B

Porte-savon mural
Wall mounted soap dish
Seifenschale zur Wandmontage



Ref. A7L.20SG

Mélangeur de bain 3 trous mural
Wall mounted 3-hole bath mixer
3-Loch-Wannenfüllbatterie
zur Wandmontage



Ref. A7L.151

Mélangeur de lavabo 3 trous
Rim mounted 3-hole basin mixer / 3-Loch-Waschtischbatterie







Collection Prestige

design
J
D
CREATIONS
Jean-Claude DELPOND
PARIS





Ref. A8B.20GA
 Mélangeur de lavabo 3 trous mural
 Wall mounted basin set
 3-Loch-Waschtischbatterie zur Wandmontage



Ref. A8B.538AC
 Porte-papier
 Wall mounted WC paper holder
 WC-Papierhalter



Ref. A8B.536
 Porte-verre mural
 Wall mounted tumbler
 Wandglashalter mit Glas



Ref. A8B.500
 Porte-savon mural
 Wall mounted glass soap dish
 Seifenschale zur Wandmontage





Ref. A8F
Cristal de roche
Rock crystal
Bergkristall



Ref. A8H
Quartz rose
Rose quartz
Rosenquarz



Ref. A8B
Améthyste
Amethyst
Amethyst



Ref. A8N
Jaspe rouge
Red jasper
Roter Jaspis



Ref. A8M
Malachite
Malachite
Malachit



Ref. A8R
Œil de Tigre
Tiger eye
Tigerauge



Ref. A8S
Lapis lazuli
Lapis lazuli
Lapis Lazuli



Ref. A8P
Onyx noir
Black onyx
Schwarzer Onyx



Ref. A8B.504N
Anneau porte-serviette Ø 180 mm
Single towel ring Ø 180 mm / 7"
Handtuchring Ø 180 mm

Ref. A9B
Cristal satiné
Satinated crystal
Satinierter Kristall



Ref. A9D
Quartz rose
Rose quartz
Rosenquarz



Ref. A9C
Onyx noir
Black onyx
Schwarzer Onyx



Ref. A9C.536
Porte-verre mural
Wall mounted tumbler
Wandglashalter mit Glas



Ref. A9C.25SG
Mélangeur de bain 3 trous sur gorge
Rim mounted 3-hole bath mixer
3-Loch-Wannenfüllbatterie zur Standmontage



Ref. A9C.538AC
Porte-papier
Wall mounted WC paper holder
WC-Papierhalter

Ref. A9C.151
Mélangeur de lavabo 3 trous
Rim mounted 3-hole basin mixer
3-Loch-Waschtischbatterie





72 PRESTIGE

Ref. AIK.151

Mélangeur de lavabo 3 trous
Rim mounted 3-hole basin mixer
3-Loch-Waschtischbatterie

Amboise

design

CREATIONS
Ainsi... Créateur 1822/2016
17625

Ref. A1L
Jaspe rouge
Red jasper
Roter Jaspis



Ref. A1J
Malachite
Malachite
Malachit



Ref. A1M
Onyx noir
Black onyx
Schwarzer
Onyx



Ref. A1K
Lapis lazuli
Lapis lazuli
Lapis Lazuli



Ref. A1K.2155
Mélangeur de lavabo monotrou
Rim mounted one-hole basin mixer
1-Loch-Zweigriff-Waschtischbatterie



Ref. A1K.5100B
Garniture pour mitigeur thermostatique
Trimings for thermostat
Thermostat-Garnitur



Ref. A1K.504N
Anneau porte-serviette Ø 180 mm
Single towel ring Ø 180 mm / 7"
Handtuchring Ø 180 mm



Ref. UIS.151

Mélangeur de lavabo 3 trous
Rim mounted 3-hole basin mixer
3-Loch-Waschtischbatterie



Ref. UIS
 Honey onyx
 Honey onyx
 Honey Onyx



Ref. UIT
 Onyx noir
 Black onyx
 Schwarzer Onyx



Ref. AIV
 Malachite
 Malachite
 Malachit



Ref. AIX
 Jaspe rouge
 Red jasper
 Roter Jaspis



Ref. AIW
 Lapis lazuli
 Lapis lazuli
 Lapis Lazuli



Ref. UIS.2155
 Mélangeur de lavabo monotrou
 Rim mounted one-hole basin mixer
 1-Loch-Zweigriff-Waschtischbatterie



Ref. UIS.536
 Porte-verre mural
 Wall mounted tumbler
 Wandglashalter mit Glas



Ref. UIS.500
 Porte-savon mural
 Wall mounted glass soap dish
 Seifenschale zur Wandmontage





Ref. A3C.151

Mélangeur de lavabo 3 trous
Rim mounted 3-hole basin mixer
3-Loch-Waschtischbatterie



Ref. A3C.20G

Mélangeur de bain 3 trous mural
Wall mounted 3-hole bath mixer
3-Loch-Wannenfüllbatterie zur Wandmontage



Ref. A3C.544GM

Coupe à poser Ø 150 mm
Soap dish on stand Ø 150 mm / 6"
Standseifenschale Ø 150 mm



Ref. A3C.2155

Mélangeur de lavabo monotrou
Rim mounted one-hole basin mixer
1-Loch-Zweigriff-Waschtischbatterie



Ref. A3C.514

Porte-serviette avec 1 barre fixe L 700 mm
Single towel rail - fixed rail L 700 mm / 27 1/2"
Handtuchstange 700 mm



Ref. A3B
Jaspe rouge
Red jasper
Roter Jaspis



Ref. A3C
Onyx noir
Black onyx
Schwarzer Onyx

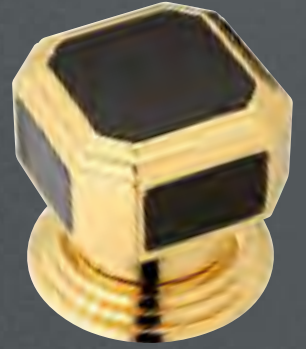

Ref. A3E
Lapis lazuli
Lapis lazuli
Lapis Lazuli

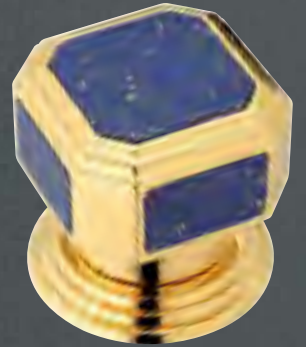

Ref. A3F
Malachite
Malachite
Malachit



Ref. A3G
Œil de Tigre
Tiger eye
Tigerauge

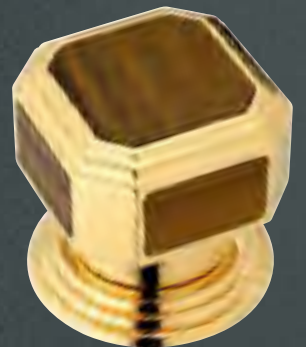



Duomo

design
CD
CREATIONS
Avec Classe 2022/2016
11602



Ref. U4E.151

Mélangeur de lavabo 3 trous - Métal
Rim mounted 3-hole basin mixer - Metal
3-Loch-Waschtischbatterie - Metall



Ref. U4F.538AC

Porte-papier
Wall mounted WC paper holder
WC-Papierhalter



Ref. U4F.52

Ensemble de douche
avec sortie coudée
Shower set
Duschkombination



Ref. U4F.4720C

Ensemble pot à balai mural
Wall mounted WC brush set
WC-Bürstentopf-garnitur



Ref. U4F.151

Mélangeur de lavabo 3 trous - Cristal
Rim mounted 3-hole basin mixer - Crystal
3-Loch-Waschtischbatterie - Kristall

PRESTIGE

79

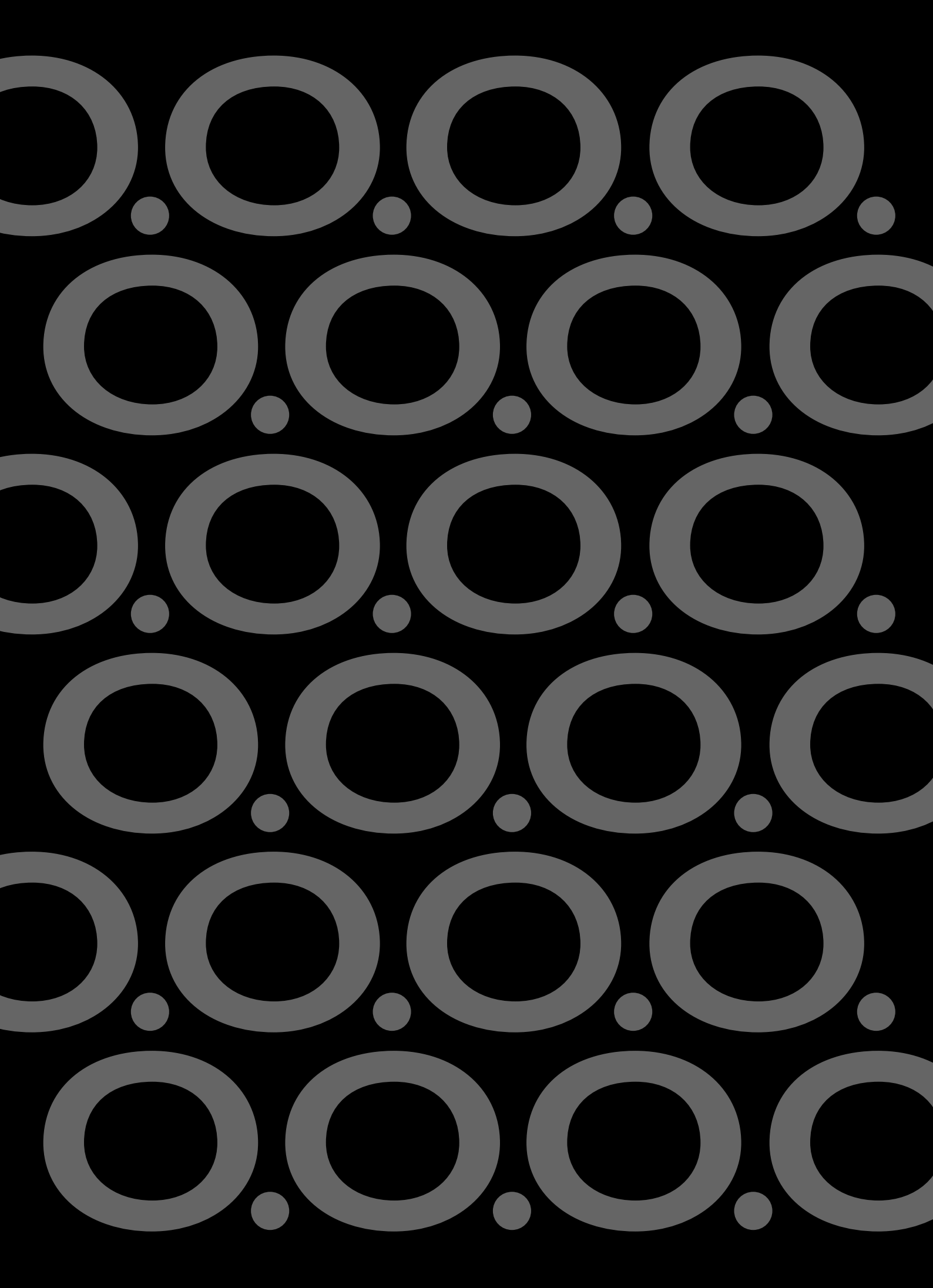

Collection



Observateur de nouveaux modes de vie, Olivier Gossart s'inscrit dans cette génération de créateurs boulimiques, qui aiment se confronter à de multiples problématiques et qui toujours découvrent de nouvelles manières de vivre l'espace. Alors qu'il travaille sur un projet d'hôtel prestigieux à Courchevel, lui vient l'idée d'unir sa marque au nom de THG, fabricant français de robinetterie de luxe dont la réputation n'est plus à faire. Il crée ainsi une ligne contemporaine et résolument design.

Keen observer of new ways of living, Olivier Gossart belongs to a generation of workaholic creators who love facing countless challenges for which they eventually always find new means of making space alive. While he was working on a project for a prestigious hotel in Courchevel, Olivier Gossart thought of linking his brand to THG's, the famous French manufacturer of luxurious bathroom fittings and accessories. A short time later, he created a line of modern and design-driven faucets.

Olivier Gossart ist ein kühner Beobachter neuer Lebensweisen. Er gehört zu einer Generation vielseitig aktiver Künstler und schätzt es, sich unterschiedlichster Herausforderungen zu stellen und neue Wege aufzuspüren, Räume lebendig zu gestalten. Während eines Projekts für ein renommiertes Hotel in Courchevel, hatte er die Idee, seine Marke mit THG Paris, dem namhaften französischen Hersteller von Luxusarmaturen und -accessoires, zu verbinden. Kurz darauf entwarf er eine zeitgemäße, durch modernes Design geprägte Kollektion.







Ref.U2K.151/P

Mélangeur de lavabo sur plaque

Plate-mounted basin set

Waschtischbeckenmischer auf Platte eingebaut



Ref.U2K.151/P

Mélangeur de lavabo sur plaque

Plate-mounted basin set

Waschtischbeckenmischer auf Platte eingebaut

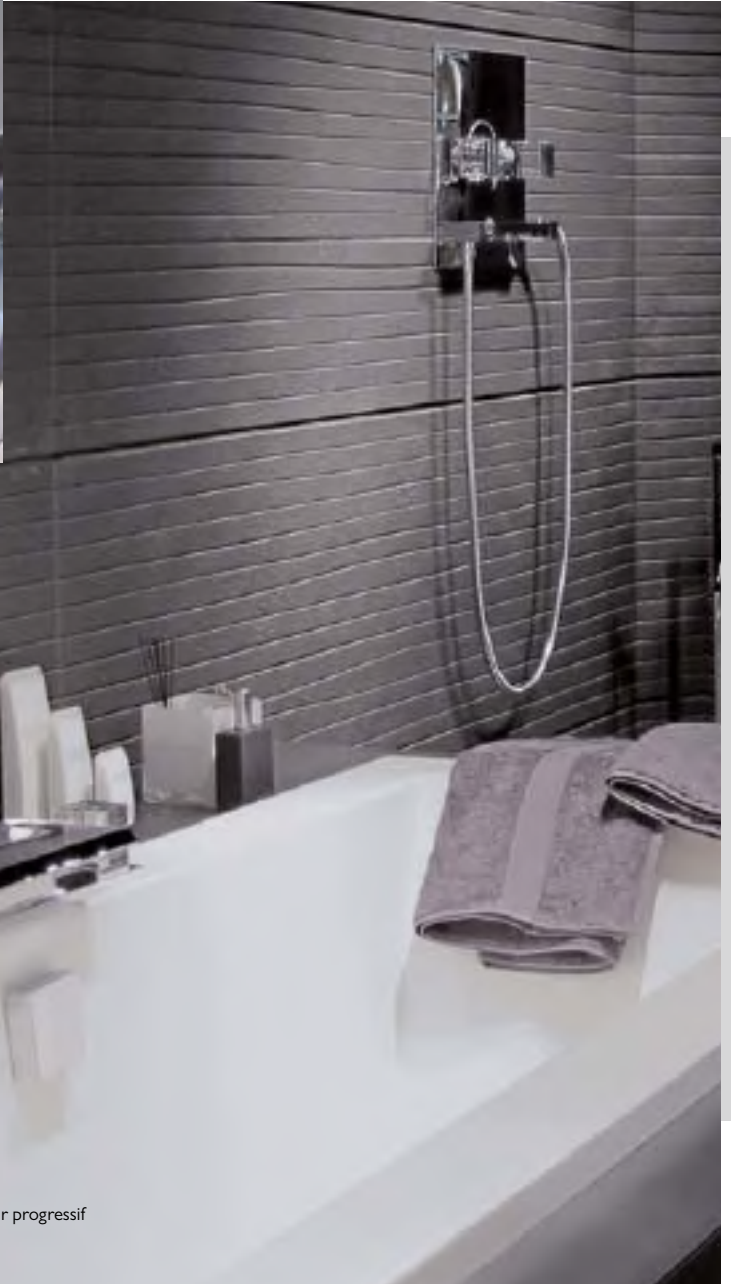

Ref.U2K.1131/PL

Mélangeur bain-douche sur plaque avec douchette alimentée par mitigeur progressif

Plate mounted exposed tub-filler with progressive valve handshower

Wannenbatterie auf Platte eingebaut mit Handbrause



Ref.U2K.5400D/B

Garniture pour mitigeur de douche thermostatique
Trim for shower thermostat
Thermostat-Garnitur mit Handbrause

o.gossart® 85

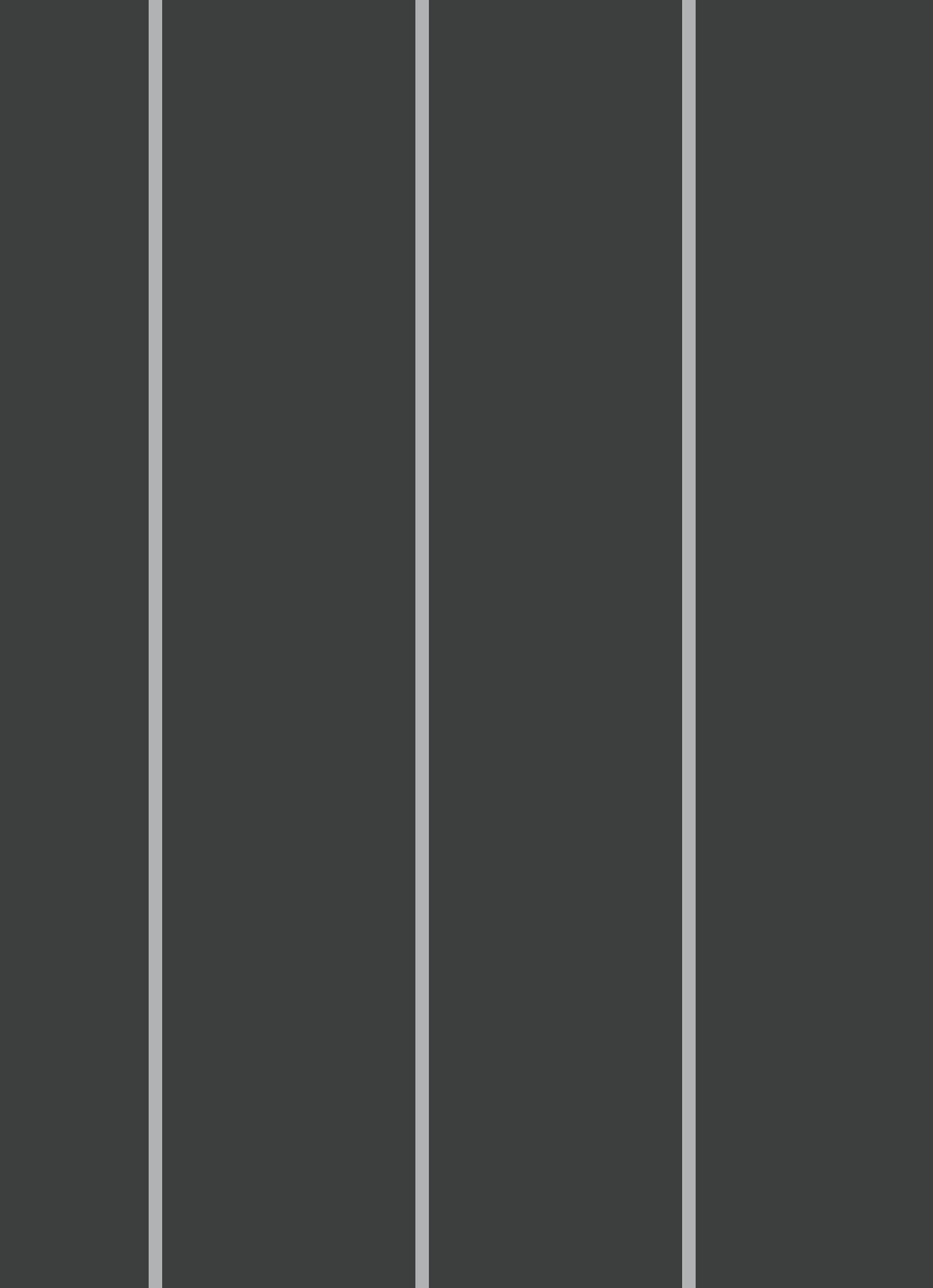

Collection

AP

ALBERTO PINTO

C'est en travaillant sur des projets communs, comme des yachts de luxe ou des villas prestigieuses, que THG, fabricant français de robinetteries et d'accessoires de salles de bains haut de gamme et le célèbre architecte d'intérieur Alberto Pinto se sont rencontrés. Très heureux de cette belle collaboration, M. Pinto, toujours en quête de nouveaux défis, a proposé à THG de réaliser une série de robinetterie.

It is through working on joint projects, such as luxury yachts and prestigious villas that THG, a French top-end taps and bathroom accessory manufacturer and the well known interior designer, Alberto Pinto crossed paths. Delighted to be part of this venture, Mr Pinto, who is always on the look out for new challenges, offered to create a range of taps and fittings for THG.

Bei gemeinsamen Projekten wie Luxusyachten oder Villen kreuzten sich die Wege des berühmten Innenarchitekts Alberto Pinto und THG Paris dem französischen Hersteller hochwertiger Badezimmerarmaturen und -accessoires. Immer auf der Suche nach neuen Herausforderungen und erfreut über die gute Zusammenarbeit, schlug Alberto Pinto vor, eine Armaturensérie für THG Paris zu entwerfen.



Le II by Alberto Pinto

by 
CREATIONS
Avec un esprit d'innovation
Paris



Ref. U2A.151

Mélangeur de lavabo 3 trous
Rim mounted 3-hole basin mixer
3-Loch-Waschtischbatterie



Ref. U2A.1132/A

Mélangeur de bain sur gorge avec douchette alimentée
par mitigeur progressif
*Rim mounted bath mixer + handshower set with single lever mixer
with progressive cartridge*
Wannenbatterie mit 1-Loch-Einhandmischer mit Brausegarnitur
und progressiver Kartusche

Ref. U2A.5500B — 54

Garniture pour mitigeur thermostatique avec inverseur 2 sorties — Ensemble de douche
Trim for THG thermostat with a 2-way diverter — Shower set
Thermostat-Thermostat-Garnitur mit Temperatureinstellung / mit Absper-
und Umstellfunktion (2 Wege) — Duschkombination

88

ALBERTO PINTO



OFF



Ref. U2A.6500S

Mitigeur de lavabo colonne,
fixation et alimentation au sol
Free-standing wash basin mixer
Freistehender Waschtisch-
Einhebelmischer

90

AP
ALBERTO PINTO

Le II by Alberto Pinto



Ref. U2A.514/ 60

Porte-serviette avec 1 barre fixe L 600 mm
Single towel rail - fixed rail L 600 mm / 24"
Handtuchstange 600 mm



Ref. U2A.6509BC

Mitigeur bain-douche mural 1/2" EA 150 mm
Wall mounted 2-hole bath shower single lever mixer
Wannenfüll- und Brausearmatur mit Einhebelmischer,
Achsabstand 150 mm



Ref. U2A.6500D

Mitigeur de lavabo monotrou
Single lever basin mixer
Washtisch-Einhebelmischer,
mittleres Modell



Ref. U2A.6529CD

Ensemble de douche thermostatique
Wall mounted shower thermostatic set
Thermostat Duschbatterie

Ref. U2A.6508S

Mitigeur bain-douche sur colonne avec flexible et douchette anti-calcaire
Free-standing bath mixer with anti-scale handshower
Freistehende Wannenstandarmatur mit Einhebelmischer und Handbrause mit Antikalksystem



Le II by Alberto Pinto

à manettes

by

 CREATIONS
 Avenue de la République
 PARIS



Ref. U2B.151

Mélangeur de lavabo 3 trous
 Rim mounted 3-hole basin mixer
 3-Loch-Waschtischbatterie



Ref. U2B.544GM

Coupe à poser Ø 150 mm
 Soap dish on stand Ø 150 mm / 6"
 Standseifenschale Ø 150 mm



Ref. U2B.504N

Anneau porte-serviette Ø 180 mm
 Single towel ring Ø 180 mm / 7"
 Handtuchring Ø 180 mm



Ref. U2B.5500B — 54 — 490

Garniture pour mitigeur thermostatique avec inverseur 2 sorties
 Ensemble de douche — Pomme inox 535 x 160 mm
 Trim for THG thermostat with a 2-way diverter — Shower set —
 Stainless steel showerhead 535 x 160 mm / 21" x 6"
 Thermostat-Garnitur mit
 Temperatureinstellung / mit Absperr
 und Umstellfunktion (2 Wege) — Duschkombination
 Brausekopf auf Edelstahl 535 x 160 mm

Ref. U2B.6500

Mitigeur de lavabo
 Single lever basin mixer
 Waschtisch-Einhebelmischer





Ref. U2B.1132/A

Mélangeur de bain sur gorge avec douchette alimentée par mitigeur progressif
Rim mounted bath mixer + handshower set with single lever mixer with progressive cartridge
Wannenbatterie mit 1-Loch-Einhandmischer mit Brausegarnitur und progressiver Kartusche

AP 95
ALBERTO PINTO



Collection

JAMIE DRAKE

Pour créer son style brillant et signé, Jamie Drake se complait à utiliser les couleurs, à mélanger les styles et les époques et à façonner les intérieurs à l'image de leurs résidents. L'audace, le raffinement, l'assurance, la douceur et l'humour : tels sont les ingrédients de sa potion magique.

To create his signature look, Drake embraces an eclectic mix of styles, colors and periods, fashioning uncommonly alluring interiors that express the individual personalities of their occupants.

Bold, polished, confident, suave and witty: these are the ingredients in his potent brew.

Um diesen ihm eigenen Look zu entwickeln, greift Drake auf eine vielseitige Mischung aus Stilen, Farben und Perioden zurück und gestaltet seine ungewöhnlich verführerischen Innenräume, die Ausdruck der Persönlichkeit ihrer Bewohner sind. Seine überzeugenden Kreationen braut er zusammen aus Wagemut, Schliff, Selbstvertrauen, Sanftheit und Witz.

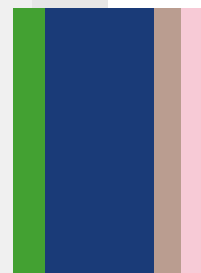

Profil métal

by
CREATIONS
JAMIE DRAKE DESIGN
PARIS



Ref. A6B.5100B
Garniture pour mitigeur thermostatique
Trimmings for thermostat
Thermostat-Garnitur



Disponible aussi en version à manettes - A6B
Also available with lever handles - A6B
Verfügbar auch mit Hebelgriffen - A6B



Ref. A6A.6500AR
Mitigeur de lavabo avec réhausse
Single lever basin mixer with raised base
Erhöhter Waschtisch-Einhebelmischer



Ref. A6A.514/ 60
Porte-serviette L 600 mm
Single towel rail L 600 mm / 24"
Handtuchstange 600 mm





100

JAMIE DRAKE



Ref. A6P.112BSG

Mélangeur bain-douche 4 trous sur gorge
Rim mounted 4-hole bath shower mixer
4-Loch-Wannenfüll- und Brausebatterie



Ref. A6P.6500

Mitigeur de lavabo
Single lever basin mixer
Waschtisch-Einhebelmischer



Ref. A6P.504N

Anneau porte-serviette Ø 180 mm
Single towel ring Ø 180 mm / 7"
Handtuchring Ø 180 mm



Disponible aussi en version croisillons - A6N
Also available with cross handles - A6N
Verfügbar auch mit Bedienungsriffen - A6N

Ref. A6P.20GA

Mélangeur de lavabo 3 trous mural
Wall mounted basin set
3-Loch-Waschtischbatterie zur Wandmontage





Collection Pierre-Yves ROCHON

D'origine bretonne, Pierre-Yves Rochon a vécu toute sa jeunesse dans de nombreux pays étrangers, ce qui a aiguisé sa curiosité du monde et donné une ouverture d'esprit à tous les courants culturels et artistiques. En 2005, il a associé son savoir-faire à celui de THG afin de développer une collection complète de robinetteries et d'accessoires dans un style très raffiné.

Born in Brittany, Pierre-Yves Rochon spent his childhood in numerous foreign countries, which sharpened his interest for the world and gave him an open-mindedness regarding all the cultural and artistic trends. In 2005, he gathered his know-how to THG's in order to offer you a complete collection of fittings and accessories in a very refined style.

Pierre -Yves Rochon, ein Bretoner im Original, bereiste schon in seiner Jugend unzählige Länder. Dies weckte seine Neugier auf die Welt und öffnete ihm die Sicht auf vielfältige kulturelle und künstlerische Strömungen. Im Jahr 2005 begann seine Kooperation mit THG. Als Resultat stellte er in Zusammenarbeit mit uns eine komplette Armaturen-Kollektion mit Accessoires in einem aufregend neuen exklusiven Stil vor.





Ref. G2R.152

Mélangeur de lavabo 3 trous bec haut
Rim mounted 3-hole basin mixer with high spout
3-Loch-Waschtischbatterie mit hohem Auslauf



Ref. G2S.500

Porte-savon mural
Wall mounted soap dish
Seifenschale zur Wandmontage



Ref. G2S.20SG

Mélangeur de bain 3 trous mural
Wall mounted 3-hole bath mixer
3-Loch-Wannenfüllbatterie zur Wandmontage



Ref. G2S.536

Porte-verre mural
Wall mounted tumbler
Wandglashalter mit Glas



Ref. G2S.504N

Anneau porte-serviette Ø 180 mm
Single towel ring Ø 180 mm / 7"
Handtuchring Ø 180 mm

Disponible aussi en version croisillons - G2R
Also available with knob handles - G2R
Verfügbar auch mit Bedienungsgriffen - G2R







Ref. G2N.112BSG

Mélangeur bain-douche 4 trous sur gorge
Rim mounted 4-hole bath shower mixer
4-Loch-Wannenfüll- und Brausebatterie



Disponible aussi en version à manettes - G2P
Also available with lever handles - G2P
Verfügbar auch mit Hebelgriffen - G2P



Ref. G2N.536
Porte-verre mural
Wall mounted tumbler
Wandglashalter mit Glas

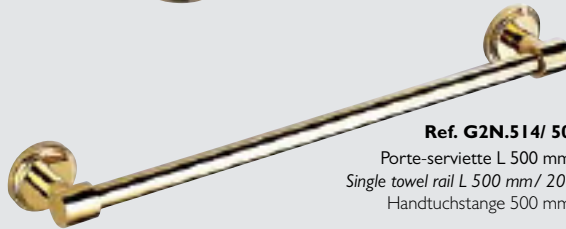

Ref. G2N.514/ 50

Porte-serviette L 500 mm
Single towel rail L 500 mm / 20"
Handtuchstange 500 mm



Ref. G2N.543M
Porte papier
Paper roll holder
Papierrollenhalter

Ref. G2N.13B

Mélangeur bain-douche mural
Wall mounted bath mixer and shower set
Wannenwandbatterie



Ref. G2N.546GM

Coupe murale Ø 150 mm
Wall mounted soap dish Ø 150 mm / 6"
Wandseifenschale Ø 150 mm

Ref. G2N.151

Mélangeur de lavabo 3 trous / Rim mounted 3-hole basin mixer / 3-Loch-Waschtischbatterie



Disponible aussi en version à manettes - G2M
Also available with lever handles - G2M
Verfügbar auch mit Hebelgriffen - G2M



Ref. G2L.3202
Mélangeur de bidet monotrou à rotule
One-hole bidet mixer swivel jet
1-Loch-Zweigriff-Bidetbatterie



Ref. G2J.20SG
Mélangeur de bain 3 trous mural
Wall mounted 3-hole bath mixer
3-Loch-Wannenfüllbatterie
zur Wandmontage



Ref. G2J.112BSG
Mélangeur bain-douche 4 trous sur gorge
Rim mounted 4-hole bath shower mixer
4-Loch-Wannenfüll- und Brausebatterie

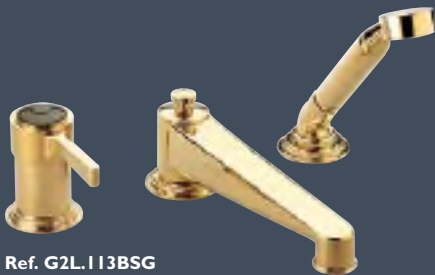

Ref. G2L.113BSG
Mitigeur bain-douche 3 trous sur gorge
Rim mounted 3-hole bath-shower mixer
3-Loch-Wannenfüll- und Brausebatterie

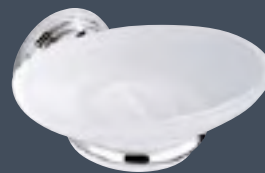

Ref. G2J.500
Porte-savon mural
Wall mounted glass soap dish
Seifenschale zur Wandmontage



Ref. G2J.536
Porte-verre mural
Wall mounted tumbler
Wandglashalter mit Glas



Ref. G2J.504N
Anneau porte-serviette Ø 180 mm
Single towel ring Ø 180 mm / 7"
Handtuchring Ø 180 mm



Disponible aussi en version croisillons - G2K
Also available with knob handles - G2K
Verfügbar auch mit Bedienungsriffen - G2K



Ref. G2L.6500
Mitigeur de lavabo
Single lever basin mixer
Waschtisch-Einhebelmischer



Ref. G2L.151

Mélangeur de lavabo 3 trous
Rim mounted 3-hole basin mixer
3-Loch-Waschtischbatterie

Disponible aussi en version croisillons - G2T
Also available with knob handles - G2T
Verfügbar auch mit Bedienunggriffen - G2T

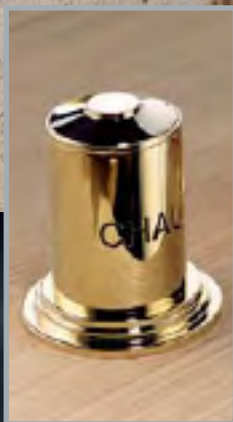

Ref. G2U.151

Mélangeur de lavabo 3 trous
Rim mounted 3-hole basin mixer
3-Loch-Waschtischbatterie



Ref. G2J.151

Mélangeur de lavabo 3 trous / Rim mounted 3-hole basin mixer / 3-Loch-Waschtischbatterie

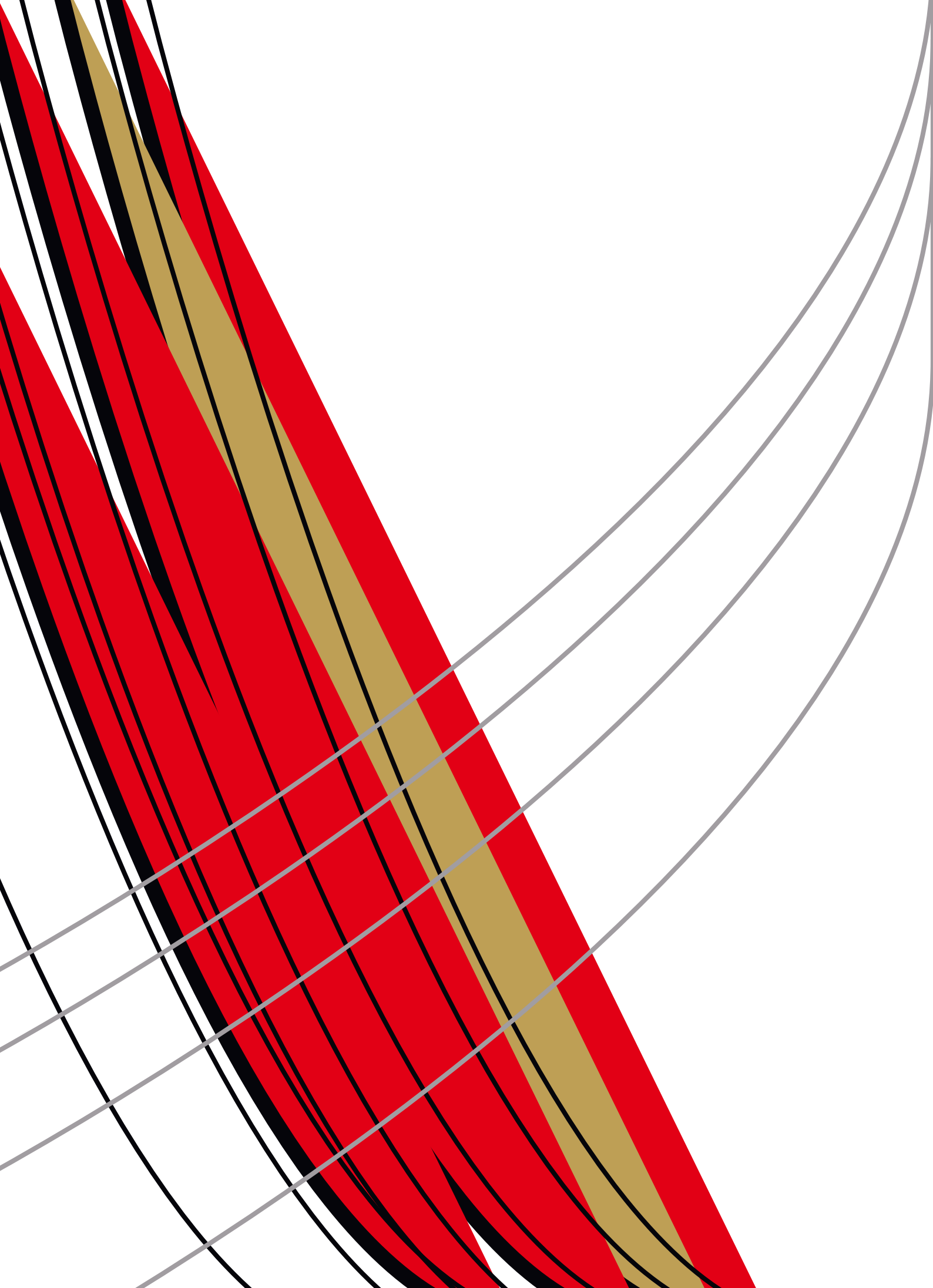

Collection
Contemporaine





Ref. A61.6500P
Mitigeur de lavabo monotrou
Single lever basin mixer
Waschtisch-Einhebelmischer



Ref. A61.510
Porte-peignoir
Robe hook
Bademantelhaken



Ref. A61.504N
Anneau porte-serviette Ø 180 mm
Single towel ring Ø 180 mm / 7"
Handtuchring Ø 180 mm



Ref. A61.546GM
Coupe porte-savon murale Ø 150 mm
Wall mounted soap dish Ø 150 mm / 6"
Wandseifenschale Ø 150 mm

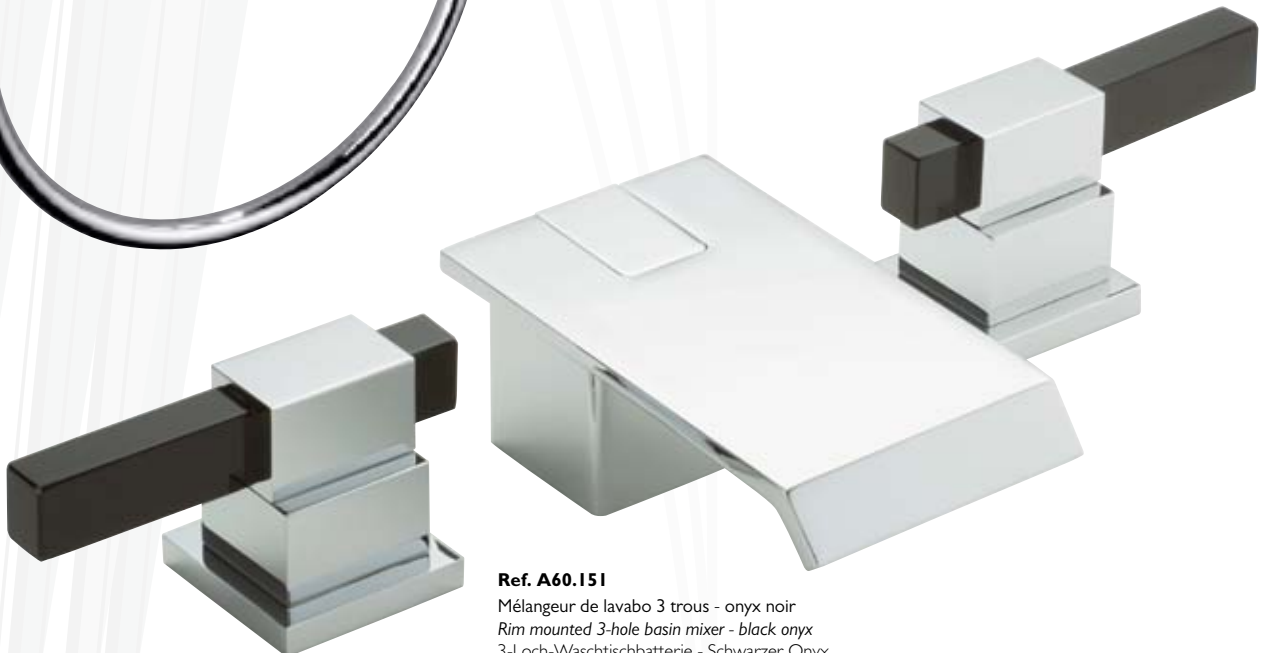

Ref. A60.151
Mélangeur de lavabo 3 trous - onyx noir
Rim mounted 3-hole basin mixer - black onyx
3-Loch-Waschtischbatterie - Schwarzer Onyx



Pure



Ref. G04.153

Mélangeur de lavabo 3 trous, modèle à manettes
Rim mounted 3-hole basin mixer with lever handles
3-Loch-Waschtischbatterie mit Hebelgriffen



Ref. G04.5100B

Garniture pour mitigeur thermostatique
Trimings for THG thermostat
Thermostat-Garnitur

Ref. G04.504N

Anneau porte-serviette Ø 180 mm
Single towel ring Ø 180 mm / 7"
Handtuchring Ø 180 mm





Beluga

Ref. GIU.6527CD

Ensemble de douche thermostatique
Wall mounted shower thermostatic set
Thermostat-Duschbatterie



Ref. GIT.151

Mélangeur de lavabo 3 trous
Rim mounted 3-hole basin mixer
3-Loch-Waschtischbatterie



Ref. GIU.20GA

Mélangeur de lavabo 3 trous mural
Wall mounted basin set
3-Loch-Waschtischbatterie
zur Wandmontage



Ref. GIU.113BG

Mitigeur bain-douche 3 trous sur gorge
Rim mounted 3-hole bath-shower mixer
3-Loch-Wannenfüll- und Brausebatterie



Ref. GIU.6500D

Mitigeur de lavabo monotrou, moyen modèle
Single lever basin mixer, medium size
Waschtisch-Einhebelmischer,
mittleres Modell







118 CONTEMPORAINE

Shao



Ref. GIV.112BSG

Mélangeur bain-douche 4 trous sur gorge
Rim mounted 4-hole bath shower mixer
4-Loch-Wannenfüll- und Brausebatterie



Ref. GIV.5500B

Garniture pour mitigeur
thermostatique avec inverseur 2 sorties
Trimings for thermostat mixer
with a 2-way diverter
Garnitür für Thermostat ref. 5500A



Ref. GIV.6500AR

Mitigeur de lavabo monotrou avec réhausse
Single lever basin mixer with raised base
Waschtisch-Einhebelmischer mit hohem Auslauf



Ref. GIW.151

Mélangeur de lavabo 3 trous
Rim mounted 3-hole basin mixer
3-Loch-Waschtischbatterie

Ref. GIV.151

Mélangeur de lavabo 3 trous
Rim mounted 3-hole basin mixer
3-Loch-Waschtischbatterie



A large, faint, light gray illustration of a floral arrangement, possibly a bouquet of flowers with various types of blooms and leaves, serves as a background for the text.

Collection Traditionnelle





Ref. A54.152

Mélangeur de lavabo 3 trous - Bec haut
Rim mounted 3-hole basin mixer - High spout
3-Loch-Waschtischbatterie mit hohem Auslauf



Ref. A54.504N

Anneau porte-serviette Ø 180 mm
Single towel ring Ø 180 mm / 7"
Handtuchring Ø 180 mm

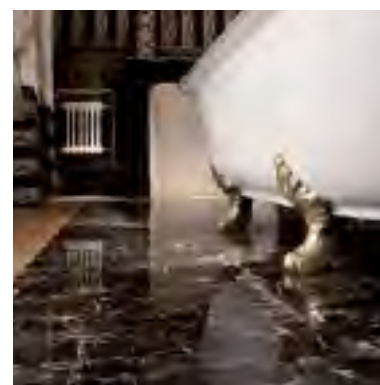
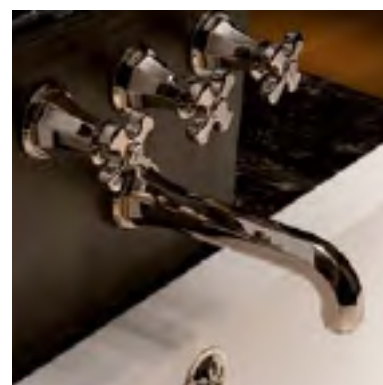

Ref. A54.151

Mélangeur de lavabo 3 trous / Rim mounted 3-hole basin mixer / 3-Loch-Waschtischbatterie



Art Déco

crystal

design
ES
CREATIONS
Jean-Claude DELZENNE
1982



Ref. A56.151

Mélangeur de lavabo 3 trous
Rim mounted 3-hole basin mixer
3-Loch-Waschtischbatterie



Ref. A56.152

Mélangeur de lavabo 3 trous - Bec haut
Rim mounted 3-hole basin mixer - High spout
3-Loch-Waschtischbatterie mit hohem Auslauf



Ref. A56.520

Porte-serviette L 700 mm
Single towel rail L 700 mm / 27 1/2"
Handtuchstange 700 mm

Ref. A56.84
Ref. G00.286
Ref. A56.15EN16EM
Ref. A56.20SG

Ensemble bain-douche thermostatique
Thermostat wall-mounted set
Duschkombination zur Wandmontage



TRADITIONNELLE

125



126 TRADITIONNELLE

Tradition à manettes

design

CREATIONS
Jean-Claude BOISSONNE
PARIS



Ref. A58.152

Mélangeur de lavabo 3 trous - Bec haut
Rim mounted 3-hole basin mixer - High spout
3-Loch-Waschtischbatterie
mit hohem Auslauf



Ref. A58.546GM

Coupe murale Ø 150 mm
Wall mounted soap dish Ø 150 mm / 6"
Wandseifenschale Ø 150 mm



Ref. A58.536

Porte-verre mural
Wall glass holder
Wandglashalter mit Glas



Ref. A58.500

Porte-savon mural
Wall mounted soap dish
Seifenschale zur Wandmontage

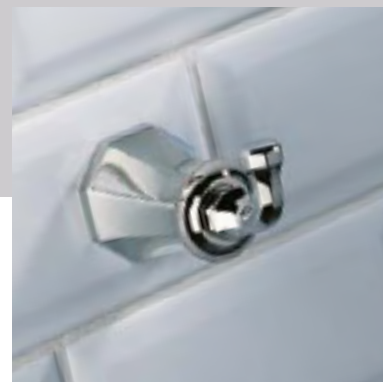

Ref. A58.517

Porte-peignoir
Robe hook
Bademantelhaken

Ref. A58.151

Mélangeur de lavabo 3 trous / Rim mounted 3-hole basin mixer / 3-Loch-Waschtischbatterie



Ref. A52.151

Mélangeur de lavabo 3 trous
Rim mounted 3-hole basin mixer
3-Loch-Waschtischbatterie

Broadway

design 
CRÉATIONS
Journé - Coudré 181221012
116825



Ref. A04.912
Manette métal lisse
Smooth metal lever handle
Glatter Metallhebelgriff



Ref. A52.49/ 3VM
Inverseur 4 voies mural
Wall mounted diverter
Umstellventil



Ref. A52.500
Porte-savon mural
Wall mounted soap dish
Seifenschale zur Wandmontage

1900



Ref. G28.151 + 2 x Ref.912

Mélangeur de lavabo 3 trous - Manettes métal lisses
Rim mounted 3-hole basin mixer - Smooth metal lever handles
3-Loch-Waschtischbatterie mit glatten Metallhebelgriffen



Ref. G28.159

Mélangeur de lavabo
Rim mounted basin mixer
Waschtischbatterie



Ref. G28.175/H + G28.175/C

Robinet de lavabo
Rim mounted pillar tap
Einloch Standventil



Ref. G28.13B

Mélangeur bain-douche mural
Wall mounted bath mixer and shower set
Wannenwandbatterie



Ref. G28.112BG

Mélangeur bain-douche 4 trous
Rim mounted 4-hole bath-shower mixer
4-Loch-Wannenfüll- und Brausebatterie



Ref. G28.514

Porte-serviette L 700 mm
Single towel rail L 700 mm / 27 1/2"
Handtuchstange 700 mm



Ref. G28.151 + 2 x Ref. 913

Mélangeur de lavabo 3 trous - Manettes métal torsadées
Rim mounted 3-hole basin mixer - Twisted metal lever handles
3-Loch-Waschtischbatterie Metallhebelgriffen - Kordel

Ref. G25.151

Mélangeur de lavabo 3 trous
Rim mounted 3-hole basin mixer
3-Loch-Waschtischbatterie

130





Ref. G29.151

Mélangeur de lavabo 3 trous
Rim mounted 3-hole basin mixer
3-Loch-Waschtischbatterie

Charleston



Ref. G29.504N

Anneau porte-serviette Ø 180 mm
Single towel ring Ø 180 mm / 7"
Handtuchring Ø 180 mm



Ref. G29.152

Mélangeur de lavabo 3 trous - Bec haut
Rim mounted 3-hole basin mixer - High spout
3-Loch-Waschtischbatterie
mit hohem Auslauf



Ref. G29.64TRD

Ensemble thermostatique
de douche avec pomme
de douche anti-calcaire
Ø 200 mm
Wall mounted shower
thermostat set with shower
head Ø 200 mm / 8"
Thermostat. Duschbatterie
mit Brausekopf Ø 200 mm
mit Antikalksystem



Ref. G29.112BGBB

Mélangeur bain-douche 4 trous sur gorge
Rim mounted 4-hole bath-shower mixer
4-Loch-Wannenfüll-und Brausebatterie



Ref. G75.151

Mélangeur de lavabo 3 trous
Rim mounted 3-hole basin mixer
3-Loch-Waschtischbatterie

Spirit



Ref. G58.151

Mélangeur de lavabo 3 trous
Rim mounted 3-hole basin mixer
3-Loch-Waschtischbatterie



Ref. G69.113BSG

Mitigeur de bain-douche 3 trous sur gorge
Rim mounted 3-hole bath-shower mixer
3-Loch Wannenfüll-und Brausebatterie



Ref. G58.20SG

Mélangeur de bain 3 trous mural
Wall mounted 3-hole bath mixer
3-Loch-Wannenfüllbatterie zur Standmontage



Ref. G69.4720C

Ensemble pot à balai mural
Wall mounted WC brush with cover
WC-Bürstentopf-garnitur



Ref. G69.538AC

Porte-papier
Wall mounted WC paper holder
WC-Papierhalter



Ref. G69.517

Porte-peignoir
Robe hook
Bademantelhaken







Collection
Intemporelle





Ref. A9F.504N
Anneau porte-serviette Ø 180 mm
Single towel ring Ø 180 mm / 7"
Handtuchring Ø 180 mm



Ref. A9F.538AC
Porte-papier
Wall mounted WC paper holder
WC-Papierhalter



Ref. A9F.546GM
Coupe murale Ø 150 mm
Wall mounted soap dish Ø 150 mm / 6"
Wandseifenschale Ø 150 mm





Ref. A9F.151

Mélangeur de lavabo 3 trous / Rim mounted 3-hole basin mixer / 3-Loch-Waschtischbatterie

INTEMPORELLE

139



140 INTEMPORELLE

Ref. **UIA.151**

Mélangeur de lavabo 3 trous / Rim mounted 3-hole basin mixer / 3-Loch-Waschtischbatterie

Mandarine métal

design

GREGATIONS
Jean-Claude GREGATIONS
PARIS



Ref. UIA.504N

Anneau porte-serviette Ø 180 mm
Single towel ring Ø 180 mm / 7"
Handtuchring Ø 180 mm

Ref. UIA.546GM

Coupe murale Ø 150 mm
Wall mounted soap dish Ø 150 mm / 6"
Wandseifenschale Ø 150 mm



Ref. UIA.2155

Mélangeur de lavabo monotrou
Rim mounted one-hole basin mixer
1-Loch-Zweigriff-Waschtischbatterie

INTEMPORELLE

| 4 |

Mandarine

cristal

design 
CREATIONS
Jean Claude FELIPPE
PARIS



Ref. UID.20GA

Mélangeur de lavabo 3 trous mural
Wall mounted basin set
3-Loch-Waschtischbatterie
zur Wandmontage

Ref. UID.504N

Anneau porte-serviette Ø 180 mm
Single towel ring Ø 180 mm / 7"
Handtuchring Ø 180 mm



Ref. UID.546GM

Coupe murale Ø 150 mm
Wall mounted soap dish Ø 150 mm / 6"
Wandseifenschale Ø 150 mm



Ref. UID.508

Porte-peignoir
Single robe hook
Bademantelhaken





Ref. UID.151

Mélangeur de lavabo 3 trous
Rim mounted 3-hole basin mixer
3-Loch-Waschtischbatterie

INTEMPORELLE 143



144 INTEMPORELLE

Mélangeur de bain 3 trous sur gorge / Rim mounted 3-hole bath mixer / 3-Loch-Wannenfüllbatterie zur Standmontage

Ref. UIF.25SG

Mandarine

cristal

design 
CREATIONS
Avenue Charles DE GAULLE
71600



Ref. UID
Cristal clair
Clear crystal
Klarer Kristall



Ref. UIF
Rosalin
Rosalin
Rosalin



Ref. UIH
Saphir
Sapphire
Saphir



Ref. UIE
Cristal satiné
Satin crystal
Satinierter Kristall



Ref. UIG
Rosalin satiné
Rosalin satin
Satinierter Rosalin



Ref. UIJ
Saphir satiné
Sapphire satin
Satinierter Saphir

Najem



Ref. E53.504N
Anneau porte-serviette Ø 180 mm
Single towel ring Ø 180 mm / 7"
Handtuchring Ø 180 mm



Ref. E53.536
Porte-verre mural
Wall mounted tumbler
Wandglashalter mit Glas



Ref. E53.538AC
Porte-papier
Wall mounted WC paper holder
WC-Papierhalter





Ref. E53.151

Mélangeur de lavabo 3 trous
Rim mounted 3-hole basin mixer
3-Loch-Waschtischbatterie

INTEMPORELLE | 47

Diplomate

design

CREATIONS
Avvio - Classe 16022/01/02
1982

Ref. U4A.2155

Mélangeur de lavabo monotrou
Rim mounted one-hole basin mixer
1-Loch-Zweigriff-Waschtischbatterie



Ref. U4A.538AC

Porte-papier
Wall mounted WC paper holder
WC-Papierhalter



Ref. U4A.546GM

Coupe murale Ø 150 mm
Wall mounted soap dish Ø 150 mm / 6"
Wandseifenschale Ø 150 mm





Ref. U4A.151

Mélangeur de lavabo 3 trous - Bagues lisses
Rim mounted 3-hole basin mixer - Smooth rings
3-Loch-Waschtischbatterie - Glatt Ring

Ref. U4B

Bagues annelées
Grooved rings
Gerieft Ring

Ref. U4C

Bagues torsadées
Roped rings
Kordel Ring

Diplomate royale

design

CREATIONS
Avec Classe depuis 1958
PARIS



Ref. U4D.20GA
Mélangeur de lavabo 3 trous mural
Wall mounted basin set
3-Loch-Waschtischbatterie zur Wandmontage



Ref. U4D.536
Porte-verre mural
Wall mounted tumbler
Wandglashalter mit Glas



Ref. U4D.500
Porte-savon mural
Wall mounted soap dish
Seifenschale zur Wandmontage



Ref. U4D.517
Porte-peignoir
Robe hook ball
Bademantelhaken



INTEMPORELLE 151

Médicis métal

design

CRÉATIONS
Ainsi Change l'ÉCOLOGIE
PARIS



Ref. A18.151

Mélangeur de lavabo 3 trous
Rim mounted 3-hole basin mixer
3-Loch-Waschtischbatterie

Ref. A18.2155

Mélangeur de lavabo monotrou
Rim mounted one-hole basin mixer
1-Loch-Zweigriff-Waschtischbatterie



Ref. A18.112BG

Mélangeur bain-douche 4 trous sur gorge
Rim mounted 4-hole bath shower mixer
4-Loch-Wannenfüll- und Brausebatterie



Ref. A18.536

Porte-verre mural
Wall mounted tumbler
Wandglashalter mit Glas



Ref. A18.510A

Porte-peignoir double
Double robe hook
Doppelter Bademantelhaken



Ref. A18.15EN16EM

Garniture pour mitigeur thermostatique
Trimings for eurotherm thermostat
Thermostat-Garnitur



Ref. A18.516

Porte-serviettes avec 2 barres fixes
Towel rail with 2 fixed rails
Handtuchstange doppelt





Collection Baroque



Amour de Trianon



Ref. G24.20A
Mélangeur de lavabo 3 trous mural
Wall mounted basin set
3-Loch-Waschtischbatterie zur Wandmontage



Ref. G24.538AC
Porte-papier
Wall mounted WC paper holder
WC-Papierhalter



Ref. G24.510A
Porte-peignoir double
Double robe hook
Doppelter Bademantelhaken



Ref. G24.536
Porte-verre mural
Wall mounted tumbler
Wandglashalter mit Glas



Ref. G24.112B
Mélangeur bain-douche 4 trous sur gorge
Rim mounted 4-hole bath shower mixer
4-Loch-Wannenfüll- und Brausebatterie



Ref. G24.504N
Anneau porte-serviette Ø 180 mm
Single towel ring Ø 180 mm / 7"
Handtuchring Ø 180 mm



Ref. G24.514
Porte-serviette L 700 mm
Single towel rail L 700 mm / 27 1/2"
Handtuchstange 700 mm







Ref. G31.112BSG

Mélangeur bain-douche 4 trous sur gorge
Rim mounted 4-hole bath shower mixer
4-Loch-Wannenfüll- und Brausebatterie



Ref. G31.538AC

Porte-papier
Wall mounted WC paper holder
WC-Papierhalter



Ref. G31.504N

Anneau porte-serviette Ø 180 mm
Single towel ring Ø 180 mm / 7"
Handtuchring Ø 180 mm



Ref. G31.4720

Ensemble pot à balai mural
Wall mounted WC brush set
WC-Bürstentopf-garnitur

Ref. G31.29SGI

Bec de bain sur gorge à inversion
Rim mounted bath spout with diverter
Wanneneinlauf zur Standmontage
mit Umstellung

Ref. G31.151

Mélangeur de lavabo 3 trous / Rim mounted 3-hole basin mixer / 3-Loch-Waschtischbatterie

Dauphin



Ref. G18.112BSG
Mélangeur bain-douche 4 trous sur gorge
Rim mounted 4-hole bath shower mixer
4-Loch-Wannenfüll- und Brausebatterie



Ref. G18.29SGI
Bec de bain sur gorge à inversion
Rim mounted bath spout with diverter
Wanneneinlauf zur Standmontage mit Umstellung



Ref. G18.500
Porte-savon mural
Wall mounted soap dish
Seifenschale zur Wandmontage



Ref. G18.536
Porte-verre mural
Wall mounted tumbler
Wandglashalter mit Glas



Ref. G18.538AC
Porte-papier
Wall mounted WC paper holder
WC-Papierhalter

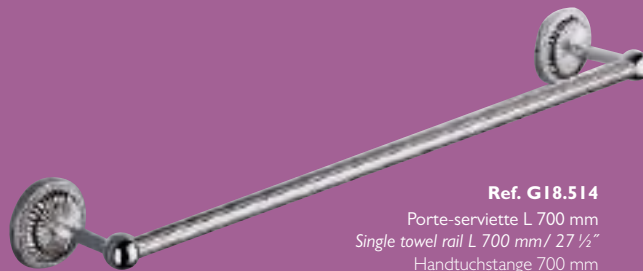

Ref. G18.514
Porte-serviette L 700 mm
Single towel rail L 700 mm / 27 1/2"
Handtuchstange 700 mm



Ref. G18.504N / 508
Anneau porte-serviette Ø 180 mm / Porte-peignoir
Single towel ring Ø 180 mm / 7" / Single robe hook
Handtuchring Ø 180 mm / Bademantelhaken





Versailles



Ref. G14.112BG
Mélangeur bain-douche 4 trous sur gorge
Rim mounted 4-hole bath shower mixer
4-Loch-Wannenfüll- und Brausebatterie

Ref. G14.500
Porte-savon mural
Wall mounted soap dish
Seifenschale zur Wandmontage



Ref. G14.504N / 508
Anneau porte-serviette Ø 180 mm / Porte-peignoir
Single towel ring Ø 180 mm / 7" / Single robe hook
Handtuchring Ø 180 mm / Bademantelhaken

Ref. G14.514
Porte-serviette L 700 mm
Single towel rail L 700 mm / 27 1/2"
Handtuchstange 700 mm



Ref. G14.20G
Mélangeur de bain 3 trous mural
Wall mounted 3-hole bath mixer
3-Loch-Wannenfullbatterie zur Wandmontage



Ref. G14.151
Mélangeur de lavabo 3 trous / Rim mounted 3-hole basin mixer / 3-Loch-Waschtischbatterie

Tête de lion



Ref. G99.22F

Tête de lion petit modèle
Wall mounted lion's head (small size)
Löwenkopf zur Wandmontage (Kleines Modell)



Ref. G99.22GM

Tête de lion romain
Wall mounted lion's head (medium size)
Löwenkopf zur Wandmontage (Mittelgroßes Modell)



Ref. G99.22TLA

Tête de lion assyrien

Wall mounted lion's head (large size)

Löwenkopf zur Wandmontage (Großes Modell)



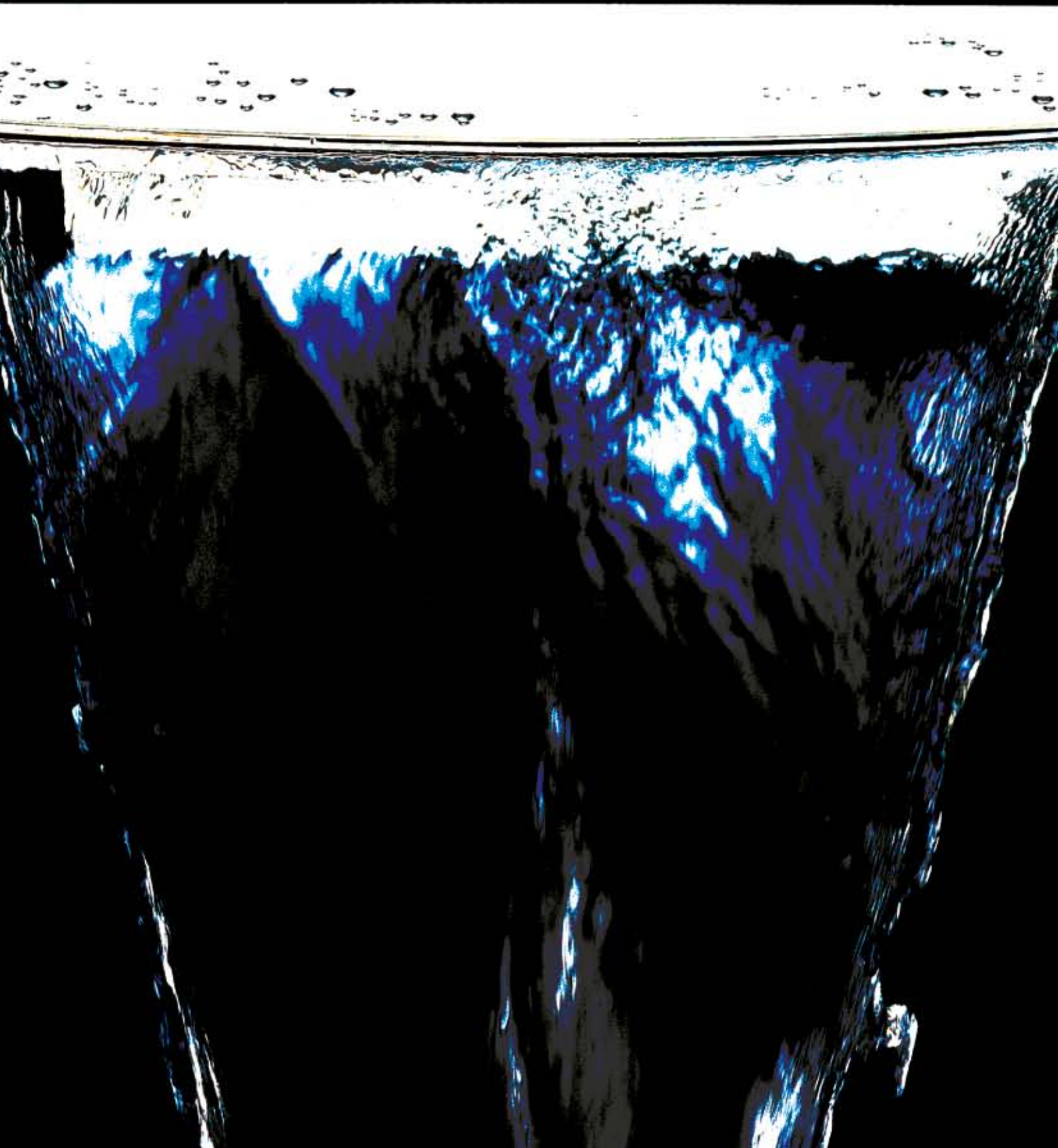

Collection Cascade





Ref. A38.29NIA/D

Bec de bain sur gorge 400 mm
Rim mounted waterfall bath spout 400 mm / 16"
Wasserfall-Wannenauslauf zur Standmontage 400 mm



Ref. A38.22NIA/A

Bec de bain mural 230 mm
Wall mounted waterfall bath spout 230 mm / 9"
Wasserfall-Wannenauslauf zur Wandmontage 230 mm

Urban

design
ES
CREATIONS
Jean-Claude FELIZZI
PARIS



Ref. A39.22NIA/E

Bec de bain mural 350 mm

Wall mounted waterfall bath spout 350 mm / 14"

Wasserfall-Wannenauslauf zur Wandmontage 350 mm



Ref. A39.29NIA/E

Bec de bain sur gorge 350 mm

Rim mounted waterfall bath spout 350 mm / 14"

Wasserfall-Wannenauslauf zur Standmontage 350 mm

CASCADE

169



170 CASCADE

Ref. A44.29NIA/D

Bec de bain sur gorge 400 mm

Rim mounted waterfall bath spout 400 mm / 16"

Wasserfall-Wannenauslauf zur Standmontage 400 mm

Ellipse

design

CREATIONS
PARIS



Ref. A44.170F + UID.35 x2
Mélangeur de lavabo 3 trous
Rim mounted 3-hole basin mixer
3-Loch Waschtischbatterie



Ref. A44.29NIA/D
Bec de bain sur gorge 400 mm
Rim mounted waterfall bath spout 400 mm / 16"
Wasserfall-Wannenauslauf zur Standmontage 400 mm

CASCADE

171

Sky showers



Ref. G00.491

Plafond de douche inox anti-calcaire chromothérapie 380 x 380 mm
 Stainless steel anti-scale sky shower chromotherapy 380 x 380 mm (15" x 15")
 Duschkopf auf Edelstahl mit chromotherapie 380 x 380 mm mit Antikalksystem



Ref. G00.481

Plafond de douche inox 650 x 650 mm
 Stainless steel sky shower, 650 x 650 mm (25 3/8" x 25 3/8")
 Duschkopf «SKY SHOWER» auf Edelstahl 650 x 650 mm

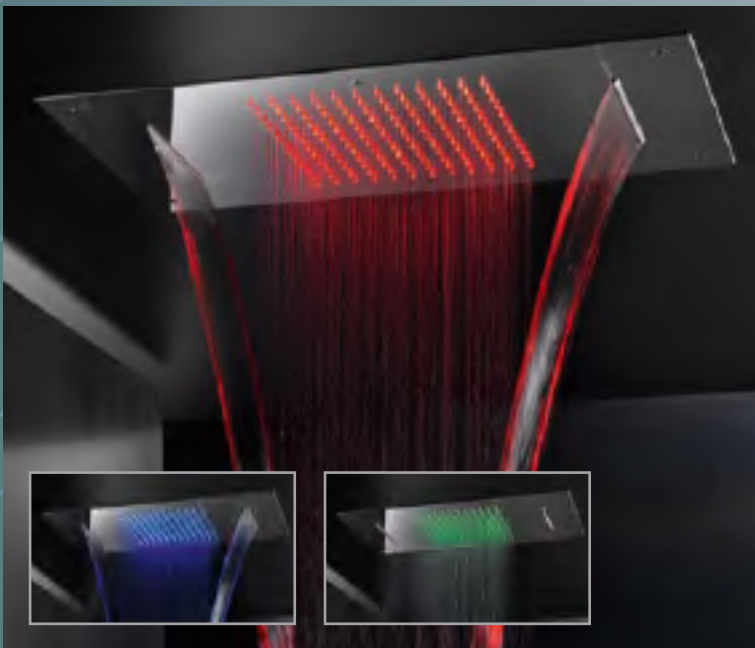

Ref. G00.492

Plafond de douche inox anticalcaire chromothérapie avec lames d'eau 700 x 380 mm
 Stainless steel anti-scale sky shower chromotherapy with water blade 700 x 380 mm (27 1/2" x 15")
 Duschkopf auf Edelstahl mit chromotherapie mit Wasserschwalm 700 x 380 mm mit Antikalksystem



Ref. G00.480

Plafond de douche inox 480 x 480 mm
 Stainless steel sky shower, 480 x 480 mm (19" x 19")
 Duschkopf «SKY SHOWER» auf Edelstahl 480 x 480 mm



Ref. G00.487

Plafond de douche anti-calcaire 445 x 445 mm
 Metal sky shower, anti-scale
 445 x 445 mm (17 1/2" x 17 1/2")
 Duschkopf «SKY SHOWER»
 445 x 445 mm, mit Antikalksystem



Ref. G00.488

Plafond de douche anti-calcaire 445 x 620 mm
 Metal sky shower, anti-scale
 445 x 620 mm (17 1/2" x 24 3/8")
 Duschkopf «SKY SHOWER»
 445 x 620 mm, mit Antikalksystem

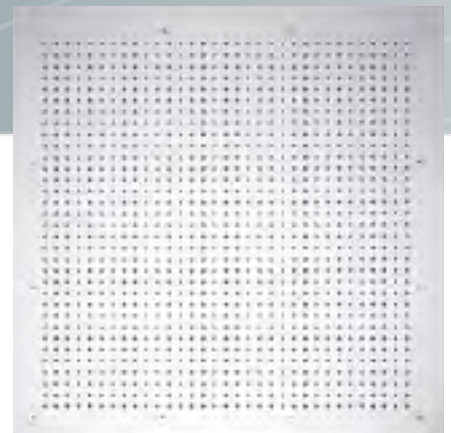

Ref. G00.489

Plafond de douche anti-calcaire 620 x 620 mm
 Metal sky shower, anti-scale
 620 x 620 mm (24 3/8" x 24 3/8")
 Duschkopf «SKY SHOWER»
 620 x 620 mm, mit Antikalksystem

Hydromassage



Ref. G00.288L
Pomme anti-calcaire Ø 70 mm
avec réglage du débit
*Adjustable showerhead, anti-scale
Ø 70 mm (2 ¾")*
Brausekopf mit Antikalksystem
Ø 70 mm - Nadelstrahl hart/weich



Ref. G00.281R
Pomme rétro anti-calcaire Ø 220 mm
Anti-scale showerhead Ø 220 mm (8 ½")
Brausekopf Ø 220 mm
mit Antikalksystem



Ref. G00.280C + Ref. 82V
Pomme anti-calcaire 300 x 300 mm
+ bras 110 mm
*Anti-scale showerhead 300 x 300 mm
(12" x 12") + shower arm 110 mm (4 ½")*
Brausekopf 300 x 300 mm
mit Antikalksystem
+ Brausearm 110 mm



Ref. G00.281C
Pomme anti-calcaire 190 x 190 mm
*Anti-scale showerhead 190 x 190 mm
(7 ½" x 7 ½")*
Brausekopf 190 x 190 mm
mit Antikalksystem



Ref. G00.280
Pomme Ø 300 mm et bras 1"
*Shower head Ø 300 mm (11 ¾")
and arm 1"*
Stachelbrausekopf mit Brausearm 1"
Ø 300 mm



Ref. G00.910PR
Pomme Ø 260 mm anti-calcaire
et bras 1"
*Anti-scale showerhead Ø 260 mm
(10 ¼") and 1" arm*
Stachelbrausekopf mit Brausearm 1"
Ø 260 mm mit Antikalksystem

Ref. G00.490
Pomme inox murale anti-calcaire 535x160 mm
Wall mounted Stainless steel anti-scale showerhead 535x160 mm (21"x6")
Brausekopf auf Edelstahl mit Antikalksystem



Ref. G00.688
Pomme à galerie Ø 120 mm
Gallery shower head Ø 120 mm (4 ¾")
Blechbrausekopf Ø 120 mm



Ref. G00.286
Pomme de douche Ø 200 mm
Shower head Ø 200 mm (8")
Stachelbrausekopf Ø 200 mm



Ref. G00.286P
Pomme de douche Ø 200 mm anti-calcaire
Anti-scale shower head Ø 200 mm (8")
Stachelbrausekopf Ø 200 mm mit Antikalksystem



Ref. G00.281EP
Pomme de douche Ø 200 mm anti-calcaire
Anti-scale shower head Ø 200 mm (8")
Stachelbrausekopf Ø 200 mm mit Antikalksystem



Vasques métal

Metal basins / Metallwaschbecken



Ref. GB2.7/BP
54 x 38,5 cm
21 1/4" x 15 1/4"

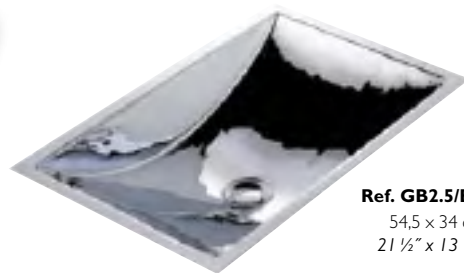

Ref. GB2.5/BP
54,5 x 34 cm
21 1/2" x 13 1/2"



Ref. GB2.6/BP
47 x 32,5 cm
18 1/2" x 12 3/4"



Ref. GB2.10/BP
37 x 37 cm
14 1/2" x 14 1/2"



Ref. GB2.4/ 3
53 x 42 cm
20 3/4" x 16 1/2"



Ref. GB2.44/BP
36 x 28 cm
14 1/4" x 11"



Ref. GB2.1/ 1
Ø 48 cm
Ø 19"



Ref. GB2.2/BP
49 x 36 cm
19 1/2" x 14 1/2"



Ref. GB2.4/BT
53 x 37 cm
20 3/4" x 14 1/2"



Ref. GB2.1/BP
Ø 39 cm
Ø 15 1/4"



Ref. GB2.11/BP
Ø 35 cm
Ø 13 3/4"



Ref. GB2.2/ 3
60 x 45 cm
23 1/2" x 17 3/4"



Ref. GB2.8/AP
Ø 41 cm - H 12 cm
Ø 16 1/4" - H 4 3/4"

Accessoires

Accessories / Accessoires



Ref. G00.623

Pont de baignoire moderne 950 x 150 mm
Bathrack 950 x 150 mm / 37 1/2" x 6"
Verstellbare Badewannenablage 950 x 150 mm



Ref. G00.2704

Boîte à mouchoirs à poser petit modèle
Tissue box small size
Taschentuchbox aus Messing zum Aufstellen,
kleines Modell



Ref. G00.704

Boîte à mouchoirs à poser grand modèle
Tissue box large size
Taschentuchbox aus Messing zum Aufstellen, großes Modell



Ref. G00.713CL

Corbeille à pédale
Waste bin with lid and pedal
Kosmetiktreymer



Ref. G00.527S

Barre de relèvement
Bath hand grip
Wannengriff



Ref. G00.4RACK2

Porte-serviettes 650 x 350 mm
Towel rail and stack 650 x 350 mm / 25 1/2" x 13 3/4"
Ablage 650 x 350 mm



Ref. G00.667

Miroir mural
Wall mounted mirror
Wandspiegel



Ref. G00.10C

Porte-serviettes sur pieds
Towel stand
Handtuchständer

TOUS STYLES 175

LES FINITIONS / FINISHES / OBERFLÄCHEN



Chrome
Polished chrome
Chrom
A02



Chromé mat
Matt chrome
Chrom matt
C02



Chromé satiné
Satin chrome
Chrom satiniert
C03



Chromé / Doré
Polished chrome / Polished gold
Chrom / Gold
G02



Doré
Polished gold
Gold
F01



Argent rhodié
Rhodium silver
Silber Rhodium
F18



Argent mat rhodié
Matt rhodium silver
Silber matt Rhodium
F19



Vieil argent verni brillant
Varnished antique silver
Altsilber lackiert
H03



Vieil argent verni mat
Varnished matt antique silver
Altsilber matt lackiert
H08



Doré satiné
Satin gold
Gold satiniert
F03



Nickel
Polished nickel
Silbernichel
B01



Nickel mat
Matt nickel
Nickel matt
C01



Nickel / Doré
Polished nickel / Polished gold
Silbernichel / Gold
G01



Nickel mat / Doré
Matt nickel / Polished gold
Nickel matt / Gold
E02



Doré mat
Matt gold
Gold matt
F07



Bronze clair verni brillant
Varnished clear bronze
Bronze Hell
D01



Bronze clair verni mat
Varnished matt bronze
Bronze Hell matt
D05



Luxbrass
Polished luxbrass
Edelmessing
H44



Luxbrass mat
Matt luxbrass
Edelmessing matt
H16



Luxbrass satiné
Satin luxbrass
Edelmessing satiniert
H12

THG
P A R I S

THG France

35, rue Tournière - BP 80212
Béthencourt sur Mer
80535 Friville cedex - France
Tel. +33 (0)3 22 60 20 80
Fax +33 (0)3 22 26 41 01
Email : contact@thg.fr
www.thg.fr

THG USA

6601 Lyons Road
Coconut Creek
FL 33073 - USA
Tel: 954 425 8225
Fax: 954 425 8301
Email: info@thgusa.com
www.thgusa.com

THG Deutschland GmbH

Gutleustr. 96
60329 Frankfurt/Main
Deutschland
Tel: +49 (0)69/ 25 78 14 33
Fax: +49 (0)69/ 25 78 14 35
Email: info@thg-deutschland.de
www.thg-deutschland.de

THG Asia Pacific

Room 1202, JinHang Tower
83 Wan Hang Du Road, Shanghai - PRC
中国上海静安区万航渡路83号金航大厦1202室
Tel. +86 (21) 61352738
Fax +86 (21) 61352737
Email: contact@thg-asia.com
www.thg.fr

© Photo Didier Grieu / François Gelly (Keppler) / Philippe Chancel (Les Crayères) / Marc Bérenguer (Cheval Blanc) / Despatin & Gobelli (O. Gagnère) / Christian Moser (Ch. Thomass)

Conception et réalisation : THG - Impression : Grupaprint - Edition mai 2012

Remerciements : Daum / Lalique / Bernardaud / Chantal Thomass / Pierre-Yves Rochon / Jamie Drake / Olivier Gagnère / Alberto Pinto / Olivier Gossart

Textes et photos non contractuels et susceptibles d'être modifiés sans préavis

Texts and pictures are not binding and can be modified without any previous notice / Texte und Fotos sind nicht Vertragsbestandteil und sind Änderungen vorbehalten

THG[®]
P A R I S

www.thg.fr